



**ExoFit NEX™**  
**Full Body Harness**  
Model Numbers: (See back pages.)

## **USER INSTRUCTION MANUAL** **EXOFIT NEX™ FULL BODY HARNESS**

*This manual is intended to meet the Manufacturer's Instructions as required by ANSI Z359 and CSA 259.10 and should be used as part of an employee training program as required by OSHA*

**WARNING:** This product is part of a personal fall arrest, restraint, work positioning, climbing, controlled descent, or rescue system. The user must follow the manufacturer's instructions for each component of the system. These instructions must be provided to the user of this equipment. The user must read and understand these instructions before using this equipment. Manufacturer's instructions must be followed for proper use and maintenance of this equipment. Alterations or misuse of this product or failure to follow instructions may result in serious injury or death.

**IMPORTANT:** If you have questions on the use, care, or suitability of this equipment for your application, contact Capital Safety.

**IMPORTANT:** Record the product identification information from the ID label in the inspection and maintenance log in Section 9 of this manual.

### **DESCRIPTIONS:**

The ExoFit NEX™ Full Body Harness is available in Vest (Figure 1) and Cross-Over (Figure 2) styles configured with a variety of features including the following:

- Tech-Lite™ Aluminum D-Rings - Varied Locations: Front, Back, Hips, Shoulders
- Duo-Lok™ Quick Connect Buckles
- Repel Technology Webbing
- Hybrid Comfort Padding
- Revolver™ Vertical Torso Adjusters
- Tongue Buckle Body Belt
- Suspension Trauma Straps

**NOTE:** Some features may not be available on all models of the ExoFit NEX™ Full Body Harness.

**EXOFIT**  
**NEX™**

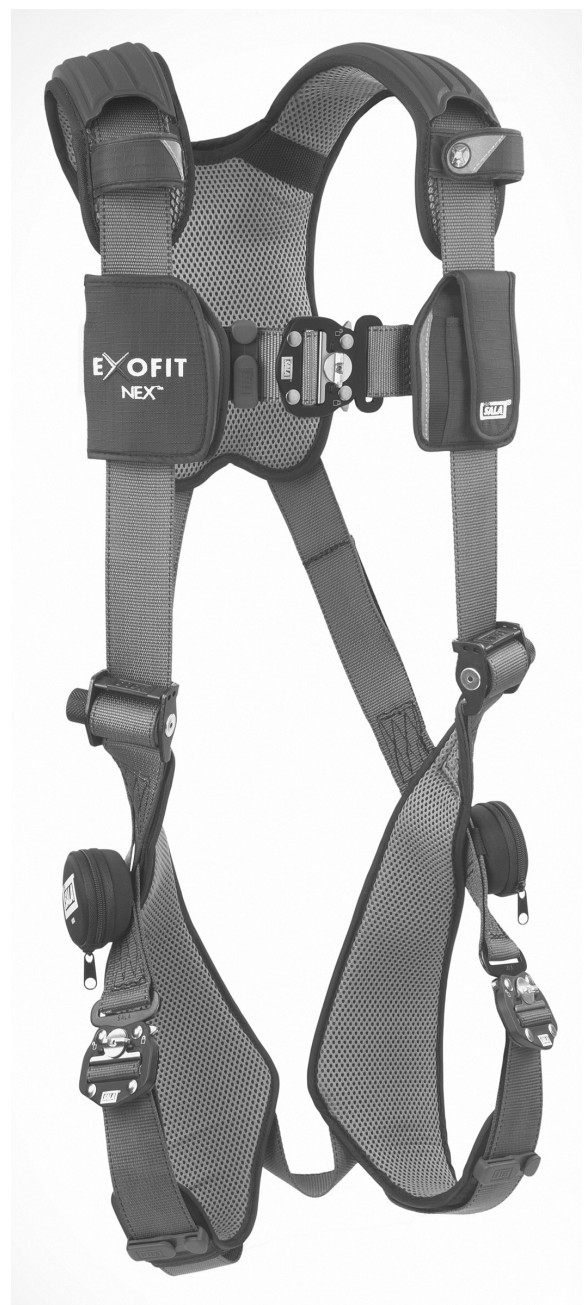

**Figure 1 - ExoFit NEX™ Vest Style Full Body Harness**



**A.** Shoulder Strap w/Hybrid Padding **B.** Duo-Lok™ Quick Connect Buckle **C.** Chest Strap **D.** Hybrid Chest Pad with i-Safe™ RFID Tag & Labels **E.** Revolver™ Torso Adjustor **F.** Tech-Lite™ Side D-Ring **G.** Leg Strap **H.** Tech-Lite™ Dorsal D-Ring **I.** Trauma Strap

**Figure 2 - ExoFit NEX™ Cross-Over Style Full Body Harness**



**A.** Shoulder Strap w/Hybrid Padding **B.** Revolver™ Adjustor **C.** Hybrid Chest Pad with i-Safe™ RFID Tag & Labels **D.** Tech-Lite™ Front D-Ring **E.** Duo-Lok™ Quick Connect Buckle **F.** Trauma Strap **G.** Tech-Lite™ Dorsal D-Ring





## 1.0 APPLICATION

**1.1 PURPOSE:** The DBI-SALA ExoFit NEX™™ Full Body Harness (Figure 1 and Figure 2) should be used as a component in personal fall arrest, restraint, work positioning, climbing, controlled descent, or rescue systems (see Table 1).

ExoFit NEX™™ Harnesses included in this manual are full body harnesses and meet ANSI Z359.1, OSHA, and CSA Z259.10 requirements. See Figure 3 for application illustrations.

**WARNING:** Working at height has inherent risks. Some risks are noted here but are not limited to: falling, suspension/prolonged suspension, striking objects, and unconsciousness. In the event of a fall arrest and/or subsequent rescue (emergency) situation, some personal medical conditions may affect your safety. Medical conditions identified as risky for this type of activity include, but are not limited to: heart disease, high blood pressure, vertigo, epilepsy, drug or alcohol dependence, psychiatric illness, impaired limb function and balance issues. We recommend that your employer/physician determine if you are fit to handle normal and emergency use of this equipment.

**Table 1 - ExoFit NEX™™ Full Body Harness Applications**

Application	CSA Class	Description
Personal Fall Arrest	Class A 	The full body harness is used as a component of a personal fall arrest system. Personal fall arrest systems typically include a full body harness and a connecting subsystem (energy absorbing lanyard). Maximum arresting force must not exceed 1,800 lbs (8 kN). For fall arrest applications connect the fall arrest subsystem (example: lanyard, SRL, energy absorber, etc.) to the D-ring or attachment element on your back, between your shoulder blades.
Controlled Descent	Class D 	For controlled descent applications, harnesses equipped with a single sternal level D-ring, one or two frontal mounted D-rings, or a pair of connectors originating below the waist (such as a seat sling) may be used for connection to a descender or evacuation system (reference in Z259.10 in Canada).
Rescue	Class E 	The full body harness is used as a component of a rescue system. Rescue systems are configured depending on the type of rescue. For limited access (confined space) applications, harnesses equipped with D-rings on the shoulders may be used for entry and egress into confined spaces where worker profile is an issue.
Ladder Climbing	Class L 	The full body harness is used as a component of a climbing system to prevent the user from falling when climbing a ladder or other climbing structure. Climbing systems typically include a full body harness, vertical cable or rail attached to the structure, and climbing sleeve. For ladder climbing applications, harnesses equipped with a frontal D-ring in the sternal location may be used for fall arrest on fixed ladder climbing systems. These are defined in CSA Z259.2.1 in Canada and ANSI A14.3 in the United States.
Work Positioning	Class P 	The full body harness is used as a component of a work positioning system to support the user at a work position. Work positioning systems typically include a full body harness, positioning lanyard, and a back-up personal fall arrest system. For work positioning applications, connect the work positioning subsystem (example: lanyard, Y-lanyard, etc.) to the lower (hip level) side or belt mounted work positioning attachment anchorage elements (D-rings). Never use these connection points for fall arrest.
Restraint	None	The full body harness is used as a component of a restraint system to prevent the user from reaching a fall hazard. Restraint systems typically include a full body harness and a lanyard or restraint line.

**1.2 STANDARDS:** Refer to local, state, and federal (OSHA) requirements governing occupational safety for additional information regarding Personal Fall Arrest Systems. Refer to the following national standards on fall protection:

ANSI	Z359.0	Definitions and Nomenclature Used for Fall Protection and Fall Arrest
ANSI	Z359.1	Safety Requirements for Personal Fall Arrest Systems, Subsystems, and Components
ANSI	Z359.2	Minimum Requirements for a Comprehensive Managed Fall Protection Program
ANSI	Z359.3	Safety Requirements for Positioning and Travel Restraint Systems
ANSI	Z359.4	Safety Requirements for Assisted-Rescue and Self-Rescue Systems, Subsystems, and Components
ANSI	A10.32	Fall Protection Systems for Construction and Demolitions
CSA	Z259.10	Full Body Harnesses
ASTM	F887-2011	Standard Specifications for Personal Climbing Equipment

**Figure 3 - Applications**

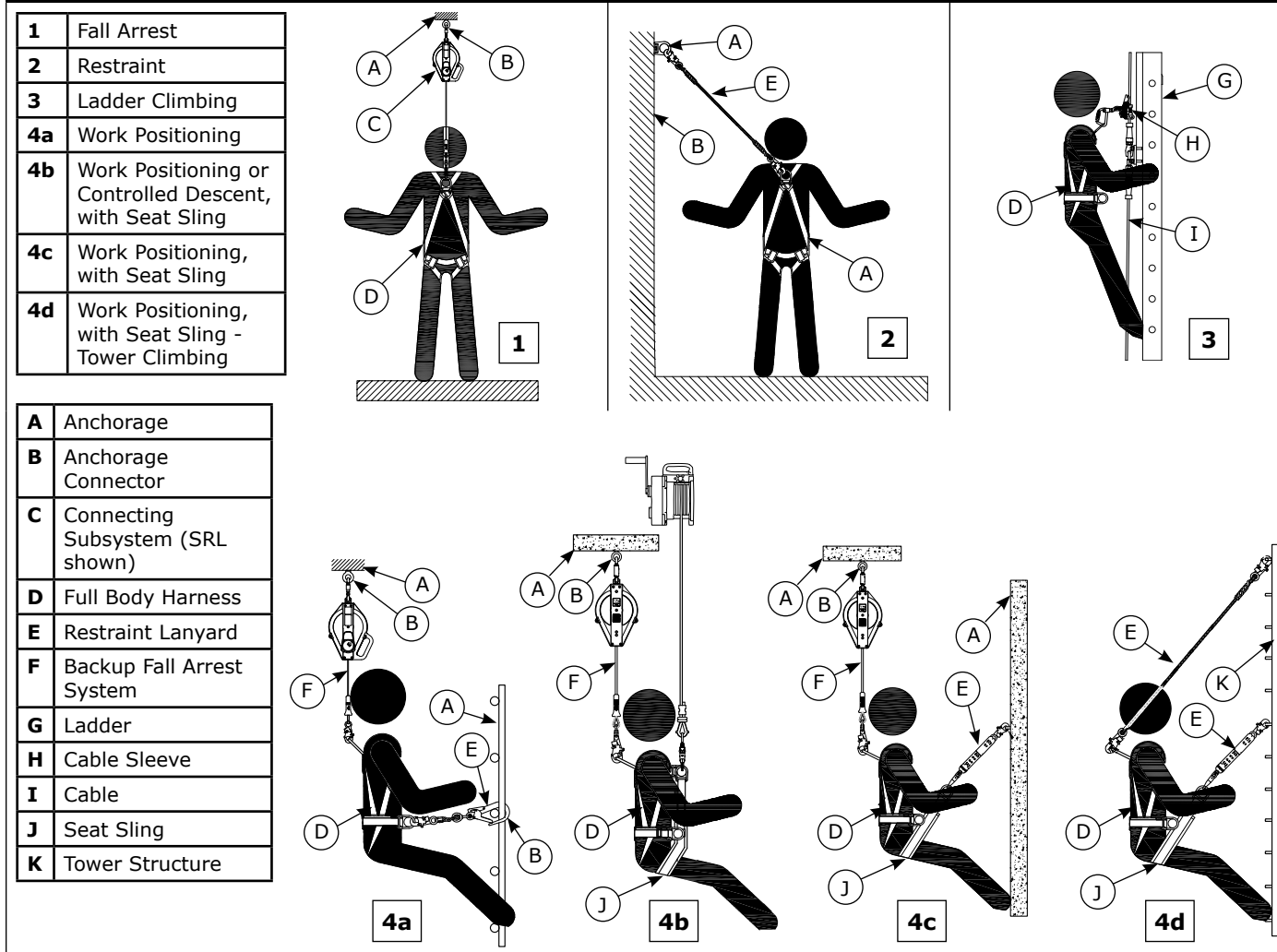

**1.3 TRAINING:** This equipment is intended to be used by persons trained in its correct application and use. It is the responsibility of the user to assure they are familiar with these instructions and are trained in the correct care and use of this equipment. Users must also be aware of the operating characteristics, application limits, and the consequences of improper use.

**2.0 SYSTEM LIMITATIONS & REQUIREMENTS**

Consider the following limitations/requirements prior to installing or using this equipment:

**2.1 CAPACITY:** ExoFit NEX™ Full Body Harnesses are designed for use by persons with a combined weight (clothing, tools, etc.) of no more than 420 lbs. (191 kg) per OSHA, 310 lbs. (141 kg) per ANSI Z359.1, or 352 lbs. (160 kg) per CSA Z259.10-06. Make sure all of the components in your system are rated to a capacity appropriate to your application.

**2.2 FREE FALL:** Personal fall arrest systems used with this equipment must be rigged to limit the free fall to 6 feet (1.8 M) per ANSI Z359.1 (see Section 7.1). Restraint systems must be rigged so that no vertical free fall is possible. Work positioning systems must be rigged so that free fall is limited to 2 feet (.6 m) or less. Personnel riding systems must be rigged so that no vertical free fall is possible. Climbing systems must be rigged so that free fall is limited to 18 in. (.46 cm) or less. Rescue systems must be rigged so that no vertical free fall is possible. See subsystem manufacturer's instructions for more information.

**2.3 FALL CLEARANCE:** Figure 4 illustrates fall clearance requirements. There must be sufficient clearance below the user to allow the system to arrest a fall before the user strikes the ground or other obstruction. Clearance required is dependent on the following factors:

- Elevation of Anchorage
- Deceleration Distance
- Worker Height
- Connecting Subsystem Length
- Free Fall Distance
- Movement of Harness Attachment Element

**Figure 4 - Fall Clearance (Lanyards)**

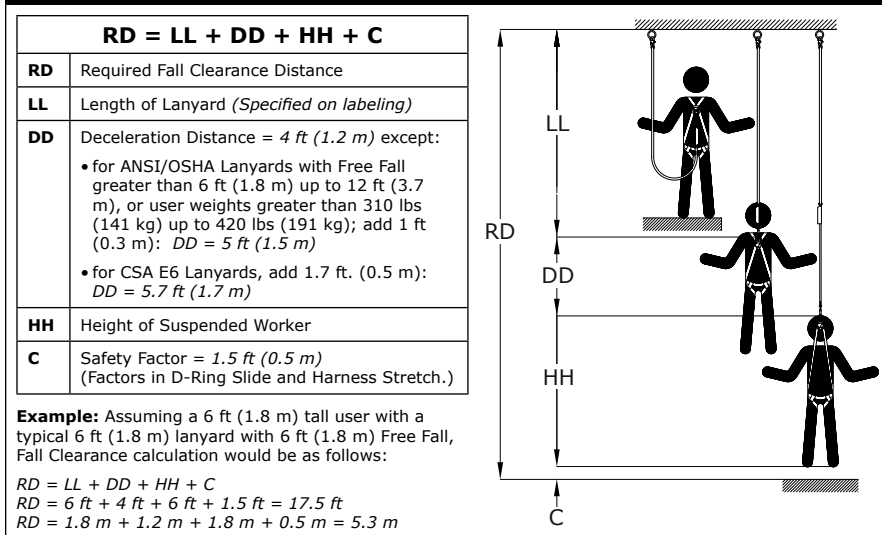

**Figure 5 - Swing Falls**

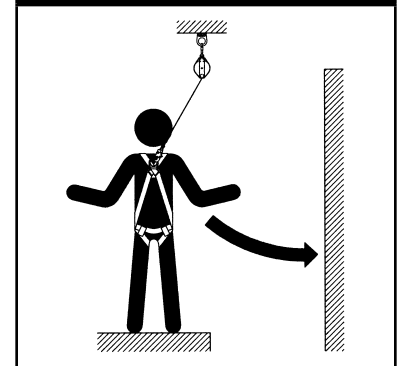

- 2.4 SWING FALLS:** Swing falls occur when the anchorage point is not directly above the point where a fall occurs. The force of striking an object in a swing fall may cause serious injury or death. Minimize swing falls by working as close to the anchorage point as possible. Do not permit a swing fall if injury could occur. Swing falls will significantly increase the clearance required when a self-retracting lifeline or other variable length connecting subsystem is used.
- 2.5 EXTENDED SUSPENSION:** A full body harness is not intended for use in extended suspension applications. If the user is going to be suspended for an extended length of time it is recommended that some form of seat support be used. DBI-SALA recommends a seat board, suspension work seat, seat sling, or a boatswain chair. Contact Capital Safety for more information on these items.
- 2.6 ENVIRONMENTAL HAZARDS:** Use of this equipment in areas with environmental hazards may require additional precautions to prevent injury to the user or damage to the equipment. Hazards may include, but are not limited to: heat, chemicals, corrosive environments, high voltage power lines, gases, moving machinery and sharp edges.
- 2.7 COMPATIBILITY OF COMPONENTS:** Unless otherwise noted, DBI-SALA equipment is designed for use with DBI-SALA approved components and subsystems only. Substitutions or replacements made with non approved components or subsystems may jeopardize compatibility of equipment and may affect safety and reliability of the complete system.
- 2.8 COMPATIBILITY OF CONNECTORS:** Connectors are considered to be compatible with connecting elements when they have been designed to work together in such a way that their sizes and shapes do not cause their gate mechanisms to inadvertently open regardless of how they become oriented. Connectors (hooks, carabiners, and D-rings) must be capable of supporting at least 5,000 lbs. (22 kN). Connectors must be compatible with the anchorage or other system components. Do not use equipment that is not compatible. Non-compatible connectors may unintentionally disengage (see Figure 6). Connectors must be compatible in size, shape, and strength. Self-locking snap hooks and carabiners are required by ANSI Z359.1 and OSHA.

**2.9 MAKING CONNECTIONS:** Use only self-locking snap hooks and carabiners with this equipment. Only use connectors that are suitable to each application. Ensure all connections are compatible in size, shape and strength. Do not use equipment that is not compatible. Ensure all connectors are fully closed and locked.

DBI-SALA connectors (snap hooks and carabiners) are designed to be used only as specified in each product's user's instructions. See Figure 7 for illustration of the inappropriate connections stated below. DBI-SALA snap hooks and carabiners should not be connected:

- A. To a D-ring to which another connector is attached.
- B. In a manner that would result in a load on the gate.
- C. In a false engagement, where features that protrude from the snap hook or carabiner catch on the anchor and without visual confirmation seems to be fully engaged to the anchor point.
- D. To each other.
- E. Directly to webbing or rope lanyard or tie-back (unless the manufacturer's instructions for both the lanyard and connector specifically allow such a connection).
- F. To any object which is shaped or dimensioned such that the snap hook or carabiner will not close and lock, or that roll-out could occur.
- G. In a manner that does not allow the connector to align with the fall arrest device (i.e., lanyard) while under load.

**NOTE:** Other than 3,600 lb. (16 kN) gated hooks, large throat opening snap hooks should not be connected to standard size D-rings or similar objects which will result in a load on the gate if the hook or D-ring twists or rotates. Large throat snap hooks are designed for use on fixed structural elements such as rebar or cross members that are not shaped in a way that can capture the gate of the hook.

**Other Restrictions:**

- Do not make connections where the hook locking mechanism can come into contact with a structural member or other equipment and potentially release the hook.
- Do not connect a snap hook into a loop or thimble of a wire rope or attach in any way to a slack wire rope.
- The snap hook must be free to align with the applied load as intended (regardless of the size or shape of the mating connector).
- A carabiner may be used to connect to a single or pair of soft loops on a body support such as a body belt or full body harness, provided the carabiner can fully close and lock. This type of connection is not allowed for snap hooks.
- A carabiner may be connected to a loop or ring connector that is already occupied by a choker style connector. This type of connection is not allowed for snap hooks.

**Figure 6 - Unintentional Disengagement (Rollout)**

If the connecting element to which a snap hook (shown) or carabiner attaches is undersized or irregular in shape, a situation could occur where the connecting element applies a force to the gate of the snap hook or carabiner. This force may cause the gate (of either a self-locking or a non-locking snap hook) to open, allowing the snap hook or carabiner to disengage from the connecting point.

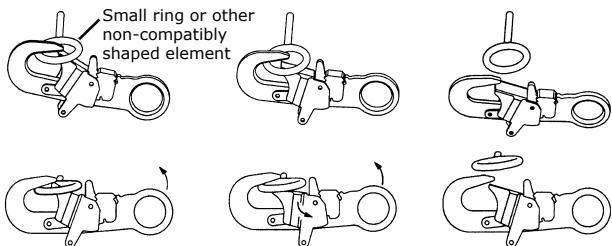

1. Force is applied to the Snap Hook.
2. The Gate presses against the Connecting Ring.
3. The Gate opens allowing the Snap Hook to slip off.

**Figure 7 - Inappropriate Connections**

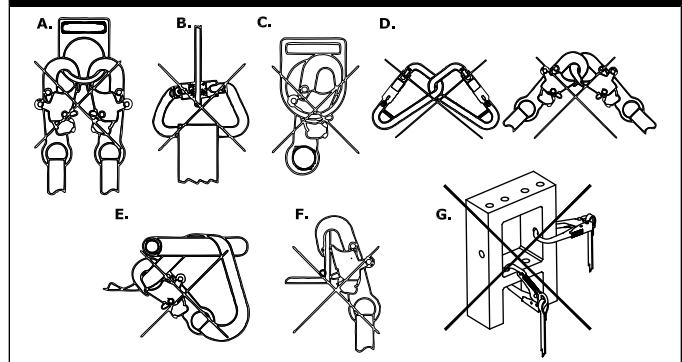

**2.10 CONNECTING SUBSYSTEMS:** Connecting subsystems (self-retracting lifeline, lanyard, rope grab and lifeline, cable sleeve) must be suitable for your application (see Table 1). See subsystem manufacturer’s instructions for more information. Some harness models have web loop connection points. Do not use snap hooks to connect to web loops. Use a self-locking carabiner to connect to a web loop. Ensure the carabiner cannot cross-gate load (load against the gate rather than along the backbone of the carabiner). Some lanyards are designed to choke onto a web loop to provide a compatible connection. See Figure 8. Lanyards may be sewn directly to the web loop forming a permanent connection. Do not make multiple connections onto one web loop, unless choking two lanyards onto a properly sized web loop.

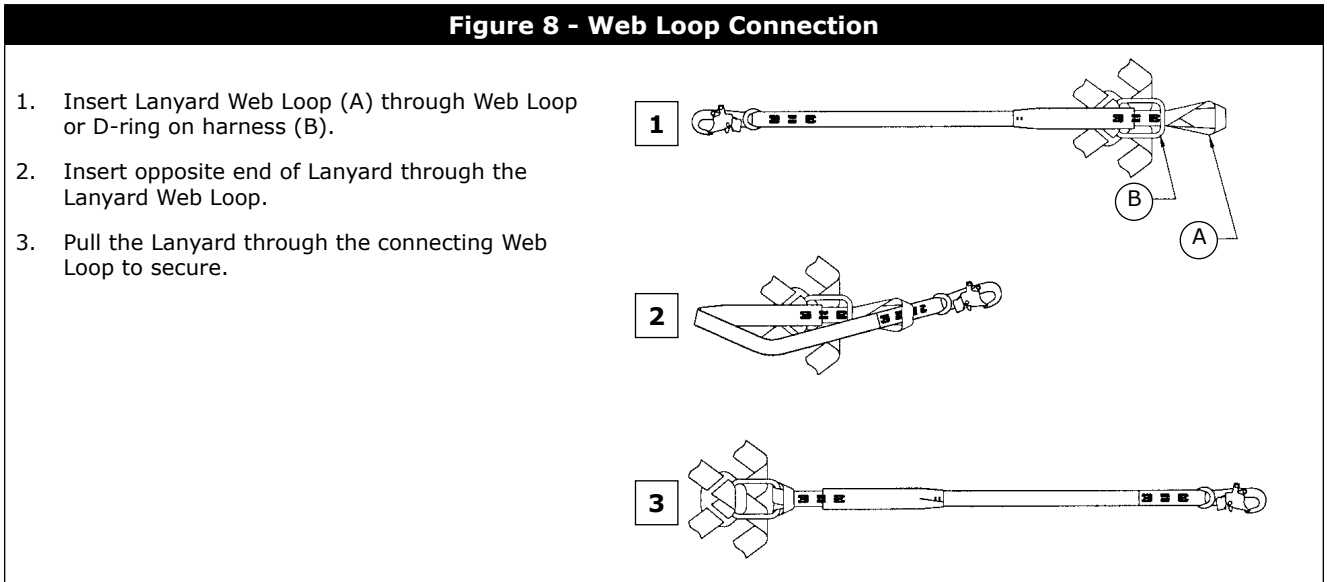

**2.11 ANCHORAGE & ANCHORAGE STRENGTH:** Anchorage and anchorage strength requirements are dependent on the full body harness application (see Figure 3). In accordance with ANSI Z359.1, anchorages selected for Fall Arrest Systems must meet the anchorage strength requirements defined in Table 2.

<b>Table 2 - Anchorage Strength Requirements</b>		
<b>Fall Arrest<sup>1</sup></b>	<i>Non-Certified Anchorages:</i>	5,000 lbs (22.2 kN)
	<i>Certified Anchorages<sup>2</sup>:</i>	2 times the Maximum Arresting Force for Certified Anchorages
<b>Restraint<sup>1</sup></b>	<i>Non-Certified Anchorages</i>	1,000 (4,5 kN)
	<i>Certified Anchorages<sup>2</sup>:</i>	2 times the foreseeable force for certified anchorages.
<b>Work Positioning<sup>1</sup></b>	<i>Non-Certified Anchorages</i>	3,000 lbs (13.3 kN)
	<i>Certified Anchorages<sup>2</sup>:</i>	2 times the foreseeable force for certified anchorages.
<b>Rescue<sup>1</sup></b>	<i>Non-Certified Anchorages</i>	3,000 lbs (13.3 kN)
	<i>Certified Anchorages<sup>2</sup>:</i>	5 times the foreseeable force for certified anchorages.
<b>Climbing</b>	The structure to which a climbing system is attached must sustain the loads required by that particular system. See the instructions for the climbing system for requirements.	
<b>1 Multiple Systems:</b> When more than one of the defined system is attached to an anchorage, the strength defined for Non-Certified or Certified anchorages shall be multiplied by the number of systems attached to the anchorage.		
<b>2 Certified Anchorage:</b> An anchorage for fall arrest, positioning, restraint, or rescue systems that a qualified person certifies to be capable of supporting the potential fall forces that could be encountered during a fall or that meet the criteria for a certified anchorage prescribed in this standard.		

### 3.0 DONNING AND USE

**WARNING:** Do not alter or intentionally misuse this equipment. Consult Capital Safety when using this equipment in combination with components or subsystems other than those described in this manual. Some subsystem and component combinations may interfere with the operation of this equipment. Use caution when using this equipment around moving machinery, electrical and chemical hazards, and sharp edges.

**3.1 BEFORE EACH USE:** Before each use of this equipment inspect the ExoFit NEX™ Full Body Harness according to Section 5 of this manual.

**3.2 PLANNING:** Plan your system before use. Consider all factors that will affect your safety during use of this equipment. Consider the following aspects when planning your system:

- **ANCHORAGE:** Select an anchorage that meets the anchorage requirements specified in Section 2.
- **SHARP EDGES:** Avoid working where system components may be in contact with, come in contact with, or abrade against, unprotected sharp edges.
- **AFTER A FALL:** Any equipment which has been subjected to the forces of arresting a fall, or exhibits damage consistent with the effect of fall arrest forces as described in Section 5, must be removed from service immediately and destroyed by the user, the rescuer<sup>1</sup>, or an authorized person<sup>2</sup>.
- **RESCUE:** The employer must have a rescue plan when using this equipment. The employer must have the ability to perform a rescue quickly and safely.

**3.3 DONNING AND FITTING THE HARNESS:** The ExoFit NEX™ Full Body Harness is available in Vest (Figure 1) and Cross-Over (Figure 10) styles. Donning procedures will vary with the harness style.

**WARNING:** Do not alter or intentionally misuse this equipment. Consult Capital Safety when using this equipment in combination with components or subsystems other than those described in this manual. Some subsystem and component combinations may interfere with the operation of this equipment. Use caution when using this equipment around moving machinery, electrical and chemical hazards, and sharp edges.

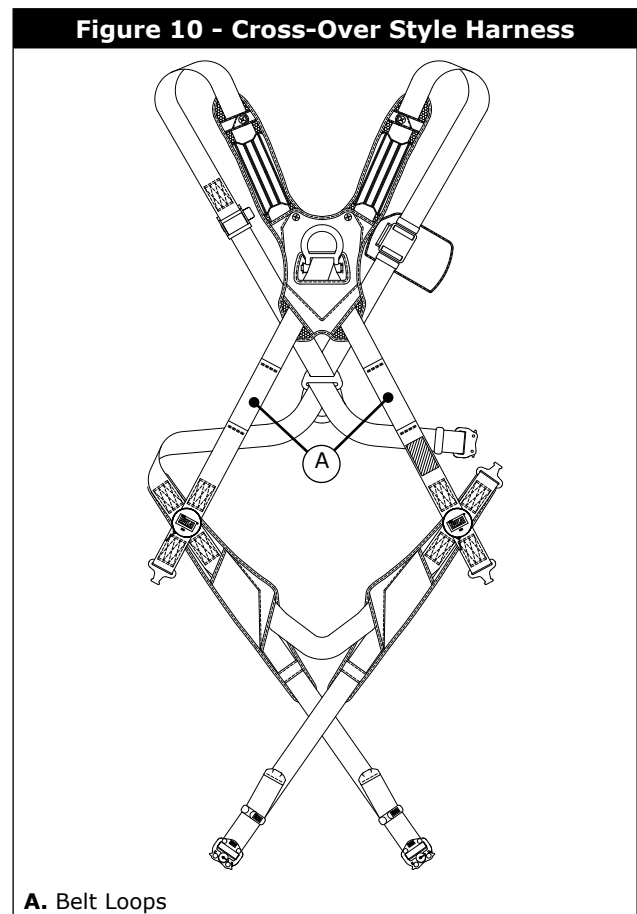
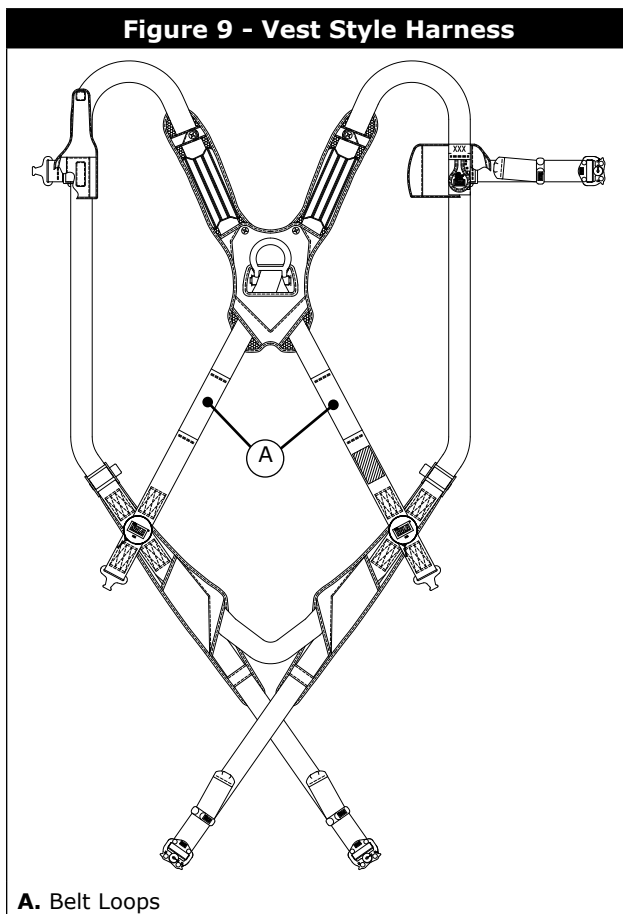





**1 Rescuer:** Person or persons other than the rescue subject acting to perform an assisted rescue by operation of a rescue system.



**2 Authorized Person:** A person assigned by the employer to perform duties at a location where the person will be exposed to a fall hazard (otherwise referred to as "user" for the purpose of these instructions).



**A. EXOFIT NEX™ VEST STYLE FULL BODY HARNESS:** The ExoFit NEX™ Vest Style Harness incorporates loops for a removable waist belt (see Figure 9). The belt can be installed through the two loops in the harness located in the lower back shoulder straps. The belt will pass through the harness just below the padded area. The hip pad, if used, is secured to the belt by passing the belt through the hip pad loops. Don the Vest Style Full Body Harness per the following steps and corresponding images in Figure 11:

- Step 1.** Locate back D-ring held in position by the D-ring pad; lift up harness and hold by this D-ring. Ensure the straps are not twisted.
- Step 2.** Grasp the shoulder straps and slip the harness onto one arm. The D-ring will be located on your back side. Ensure that the straps are not tangled and hang freely. Slip your free arm into the harness and position the shoulder straps on top of your shoulder. Ensure that the straps are not tangled and hang freely. The chest strap, with quick connect buckle, will be positioned on the front side when worn properly.
- Step 3.** Reach between your legs and grasp the gray leg strap on your left side. Bring the strap up between your legs and connect it by inserting the tab of the buckle into receptor of quick connect buckle on the left side as shown in Figure 11. You will hear a click when the tab engages properly. Connect the right leg strap using the same procedure. To adjust the leg straps, unlock  the webbing lock on the quick connect buckle and pull on the strap. A plastic end keeper on the end of the strap will stop it from pulling completely out of the buckle. When the strap is properly adjusted, lock  the webbing lock. To release the buckle, press the silver-colored tabs on the buckle towards each other with one hand, while pulling on the tab portion of the buckle with the other hand.

**NOTE:** Locking  and unlocking  the webbing lock prevents or allows the strap to slide between the sliding bar and slot on the female end of the quick connect buckle. It does not control engagement or disengagement of the buckle ends and will not affect the buckle connection in the event of a fall.

- Step 4.** Attach the chest strap by inserting the tab of the buckle into the receptor of the quick connect buckle. You will hear a click when the tab engages properly. The chest strap should be 6 in. (15 cm) down from the top of your shoulders. Pass excess strap through the loop keepers. To adjust the chest strap, unlock  the webbing lock on the quick connect buckle and pull on the strap. A plastic end keeper on the end of the strap will stop it from pulling completely out of the buckle. When the strap is properly adjusted, lock  the webbing lock. To release the buckle, press the silver-colored tabs on the buckle toward each other with one hand, while pulling on the tab portion of the buckle with the other hand.
- Step 5.** Adjust shoulder straps to a snug fit with the Vertical Torso Adjusters (see Figure 11): Left and right sides of shoulder straps should be adjusted to the same length and the chest strap should be centered on your lower chest, 6 in. (15 cm) down from shoulder. The front D-ring on the vest style harness is moved up or down by adjusting the shoulder straps and leg straps. Center the back D-ring between your shoulder blades. Note: On applicable models, the back (dorsal) D-ring can be repositioned up or down as needed for a correct fit. Adjust leg straps to a snug fit. At least 3 in. (8 cm) of webbing must extend past the buckle on the leg straps. Adjust the waist belt (if present).

**Figure 11 - Donning the ExoFit NEX™ Vest Style Full Body Harness**



**Step 1**



**Step 2**



**Step 3**

**Duo-Lok™ Quick Connect Buckles**



**Connection:** Connect buckle ends by inserting the tab into the receptor until a click is heard.



**Strap Adjustment:** Rotate Webbing Lock to unlocked position **B**. Pull strap to adjust. Rotate Webbing Lock to locked position **A**.

**NOTE:** The Webbing Lock does not control engagement or disengagement of the buckle ends.

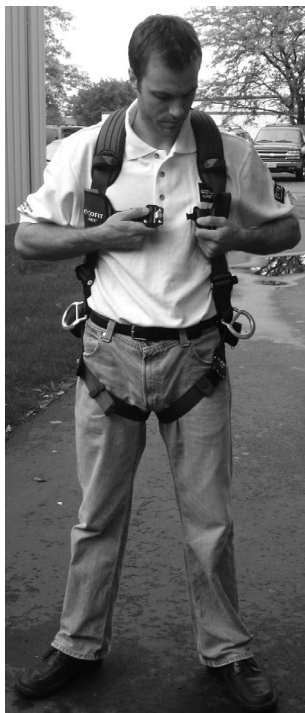

**Step 4**

**Revolver™ Vertical Torso Adjusters**

**Right**

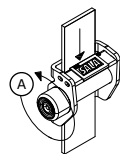

**To Tighten:** Turn Ratchet Knob in direction **A**.

**To Loosen:** Pull Ratchet Knob out and turn in direction **B**.

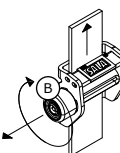

**NOTE:** After adjustment, tug upwards on the shoulder straps to ensure that each adjuster is locked in place.

**Left**

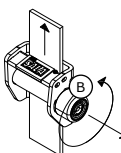
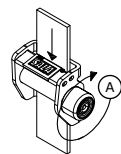

**Step 5**

**B. EXOFIT NEX™ CROSS-OVER STYLE FULL BODY HARNESS:** The ExoFit NEX™ Cross-Over Style Harness incorporates loops for a removable waist belt. The belt can be installed through the two loops in the harness located in the lower back shoulder straps (see Figure 10). The belt will pass through the harness just below the padded area. The hip pad, if used, is secured to the belt by passing the belt through the hip pad loops. Don the Cross-Over Style Full Body Harness per the following steps and corresponding images in Figure 12:

- Step 1.** Locate the back D-ring held in position by the D-ring pad; lift up the harness and hold by this D-ring. Ensure the straps are not twisted.
- Step 2.** Grasp the shoulder straps between the back and front D-ring and slip the harness over your head from the left side. Position the shoulder straps on top of your shoulders. Ensure that the straps are not tangled and hang freely. The D-ring will be positioned on your back when worn properly.
- Step 3.** Grasp the tab of the buckle located at your right hip and insert it into the receptor of the quick connect buckle (see Figure 12). You will hear a click when the tab engages properly.
- Step 4.** Reach between your legs and grasp the gray leg strap on your left side. Bring the strap up between your legs and insert the tab of the buckle into the receptor of the buckle on the left side as shown in Figure 12. You will hear a click when the tab engages properly. Connect the right leg strap using the same procedure. To adjust the leg straps, unlock **Ⓜ** the webbing lock on the quick connect buckle and pull on the strap. A plastic end keeper on the end of the strap will stop it from pulling completely out of the buckle. When the strap is properly adjusted, lock **Ⓜ** the webbing lock. To release the buckle, press the silver-colored tabs on the buckle towards each other with one hand, while pulling on the tab portion of the buckle with the other hand.

**NOTE:** Locking **Ⓜ** and unlocking **Ⓜ** the webbing lock prevents or allows the strap to slide between the sliding bar and slot on the female end of the quick connect buckle. It does not control engagement or disengagement of the buckle ends and will not affect the buckle connection in the event of a fall.

- Step 5.** Adjust shoulder straps to a snug fit with the Vertical Torso Adjusters (see Figure 12): Left and right sides of the shoulder straps should be adjusted to the same length and the front D-ring should be centered on your lower chest. The back D-ring should be centered between your shoulder blades. Note: On ExoFit XP models, the back (dorsal) D-ring can be repositioned up or down as needed for a correct fit. Adjust the leg straps to a snug fit. At least 3 in. (8 cm) of webbing must extend past the buckle on the leg straps. Adjust the waist belt (if present).

- 3.4 USE OF FALL ARREST D-RING OR ATTACHMENT ELEMENT:** For fall arrest applications connect to the D-ring or attachment element on your back, between your shoulder blades. Side D-rings, if present, are for positioning or restraint applications only. Front D-ring, if present, is for ladder climbing, positioning, or other applications with a limited free fall not exceeding 2 feet (0.6 m) with a 900 MAF requirement. For rescue, back, shoulder, or front D-rings may be used. D-rings on seat sling are for work positioning or personnel riding.
- 3.5 MAKING CONNECTIONS:** When using a hook to connect to an anchorage or when coupling components of the system together, ensure roll-out cannot occur. Roll-out occurs when interference between the hook and mating connector causes the hook gate to unintentionally open and release. Self-locking snap hooks and carabiners should be used to reduce the possibility of roll-out. Do not use hooks or connectors that will not completely close over the attachment object. See subsystem manufacturer's instructions for more information on making connections.
- 3.6 CONNECTING SYSTEM COMPONENTS:** After properly fitting the full body harness, the user may then connect to other system components. Follow the guidelines in Section 3.4 when selecting the correct attachment element.

**Figure 12 - Donning the ExoFit NEX™ Cross-Over Style Full Body Harness**



**Step 1**



**Step 2**

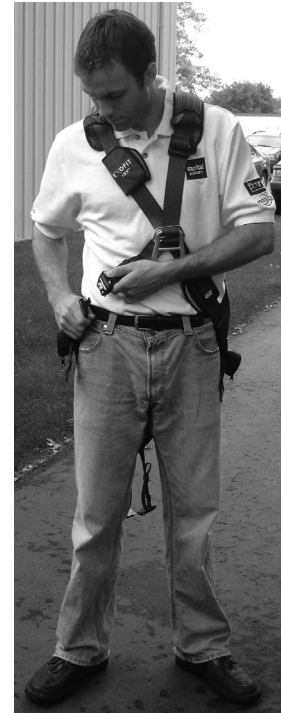



**Step 3**

**Duo-Lok™ Quick Connect Buckles**



**Connection:** Connect buckle ends by inserting the tab into the receptor until a click is heard.



**Strap Adjustment:** Rotate Webbing Lock to unlocked position . Pull strap to adjust. Rotate Webbing Lock to locked position .

**NOTE:** The Webbing Lock does not control engagement or disengagement of the buckle ends.



**Step 4**

**Revolver™ Vertical Torso Adjusters**

**To Tighten:** Turn Ratchet Knob in direction **A**.

**To Loosen:** Pull Ratchet Knob out and turn in direction **B**.

**NOTE:** After adjustment, tug upwards on the shoulder straps to ensure that each adjuster is locked in place.

**Left**

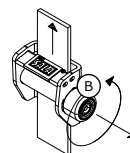
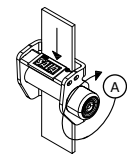

**Step 5**

**3.7 SUSPENSION TRAUMA STRAP:** The ExoFit NEX™ Full Body Harness is equipped with a Suspension Trauma Strap (Figure 13) to help prolong allowable suspension time in the event of a fall from height. It should only be used in situations where a fall has occurred or for training. To use the Suspension Trauma Strap:

- Step 1.** Unzip the Trauma Strap Pouch on each hip of the harness and deploy the Suspension Straps (Figure 13A).
- Step 2.** Raise the ends of the straps to access the hook and loops. Insert the hook into the loop that provides the desired strap length.
- Step 3.** Lower the Suspension Strap and step onto the strap to alleviate pressure of the harness leg straps on the legs (Figure 13B). Adjust the hook/loop combination for optimal comfort.

**WARNING:** Maintain an upright position following suspension. Do not lay down. Seek medical attention following a suspension.

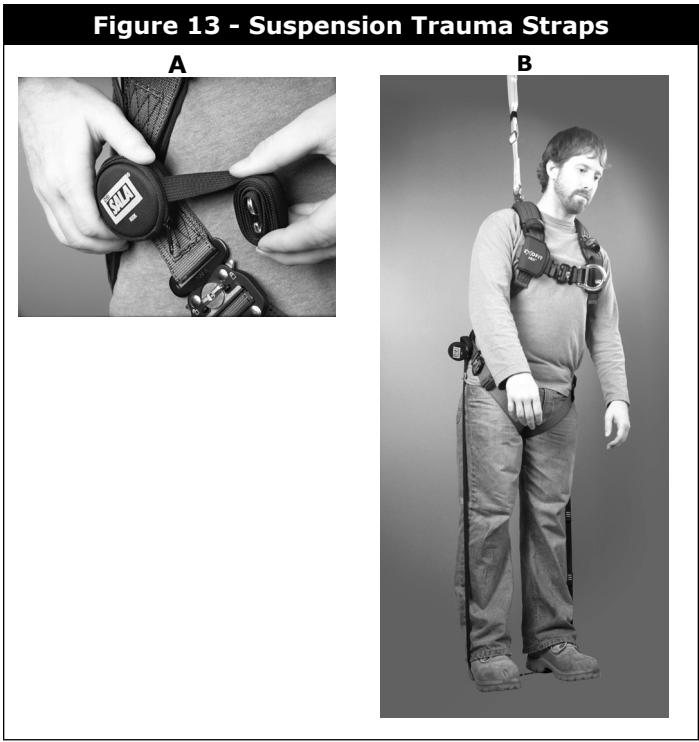

**3.8 EXOFIT NEX GLOBAL WIND ENERGY HARNESS MODEL REPLACEABLE LUMBAR PROTECTOR:** The Lumbar Protector (A) can be replaced in the field when worn or damaged. (See Figure 14)

Place the ExoFit harness on a flat surface. Pull the hip belt (B) completely out of the harness to free the worn/damaged Lumbar Protector (A) and tool loops (D, if installed).

To install the replacement Lumbar Protector:

- Step 1.** Reinsert the hip belt through the left D-Ring (C), the end of the first tool loop (D, if installed), belt loops (E) and (F), and the end of the tool loop (D).
- Step 2.** Insert the hip belt through the replacement Lumbar Protector (G), the second tool loop (H, if installed), the next two belt loops (I) and (K), the end of the tool loop (H) and the right D-Ring.

Completed installation of replacement Lumbar Protector.



## 4.0 TRAINING

It is the responsibility of the purchaser and the user of this equipment to assure that they understand these instructions and are trained in the correct care and use of this equipment. They must also be aware of the operating characteristics, application limits, and the consequences of improper use of this equipment.

**IMPORTANT:** Training must be conducted without exposing the user to a fall hazard. Training should be repeated on a periodic basis.

## 5.0 INSPECTION

**5.1 i-Safe™ RFID TAG:** The i-Safe™ RFID tag on the ExoFit NEX™ Harness (see "Figure 15 i-Safe™ RFID Tag") can be used in conjunction with the i-Safe handheld reading device and the web based portal to simplify inspection and inventory control and provide records for your fall protection equipment.



**5.2 FREQUENCY:** Before each use inspect the full body harness according to Section 5.3. The harness must be inspected by a competent person<sup>3</sup>, other than the user, at least annually. Record the results of each formal inspection in the inspection and maintenance log in section Section 9, or use the i-Safe™ inspection web portal to maintain your inspection records. If you are a first-time user, contact a Customer Service representative in the US at 800-328-6146 or in Canada at 800-387-7484 or if you have already registered, go to: [www.capitalsafety.com/isafe](http://www.capitalsafety.com/isafe). Follow instructions provided with your i-Safe handheld reader or on the web portal to transfer your data to your web log.

**IMPORTANT:** If the full body harness has been subjected to fall arrest or impact forces it must be immediately removed from service and destroyed.

**IMPORTANT:** Extreme working conditions (harsh environments, prolonged use, etc.) may require increasing the frequency of inspections.

**5.3 INSPECTION:** Inspect the ExoFit NEX™ Full Body Harness as follows:

- Step 1. Inspect harness hardware (buckles, D-rings, pads, loop keepers, vertical torso adjusters):** These items must not be damaged, broken, distorted, and must be free of sharp edges, burrs, cracks, worn parts, or corrosion. PVC coated hardware must be free of cuts, rips, tears, holes, etc. in the coating to ensure non-conductivity. Ensure that release tabs on buckles work freely and that a click is heard when the buckle engages. Inspect vertical torso adjusters for proper operation. Ratchet knobs should turn with ease in a clockwise direction and should only turn counterclockwise when the knob is pulled out.
- Step 2. Inspect webbing:** Material must be free of frayed, cut, or broken fibers. Check for tears, abrasions, mold, burns, or discoloration. Inspect stitching; check for pulled or cut stitches. Broken stitches may be an indication that the harness has been impact loaded and must be removed from service. When performing the annual formal inspection, unsnap and open the back pad to facilitate inspection of the webbing.
- Step 3. Inspect the labels:** All labels should be present and fully legible (see Section 8).
- Step 4. Inspect system components and subsystems:** Inspect each system component or subsystem according to manufacturer's instructions.

**3 Competent Person:** One who is capable of identifying existing and predictable hazards in the surroundings or working conditions which are unsanitary, hazardous, or dangerous to employees, and who has authorization to take prompt corrective measures to eliminate them.

**Step 5. Record inspection data:** Record the inspection date and results in the *Inspection and Maintenance Log* (see Section 9).

**Step 6. Inspect the Stitched Impact Indicator:** The stitched impact indicator is a section of webbing that is lapped back on itself and secured with a specific stitch pattern holding the lap (see Figure 16). The stitch pattern is designed to release when the harness arrests a fall or has been subjected to an equivalent force. If the impact indicator has been activated the harness must be removed from service and destroyed.

**Step 7. Inspect Suspension Trauma Straps:** Check the trauma strap pouches for damage and secure connection to the harness. Unzip the trauma strap pouch on each hip of the harness and inspect suspension trauma straps. Webbing and pouch material must be free of frayed, cut, or broken fibers. Check for tears, abrasions, mold, burns, discoloration, or knots. Verify that one pouch is marked 'Hook' and the other marked 'loop'.

**IMPORTANT:** If inspection reveals a defective condition, remove the unit from service immediately and destroy it.

**NOTE:** Only DBI-SALA or parties authorized in writing may make repairs to this equipment.

**Figure 16- Stitched Impact Indicator**

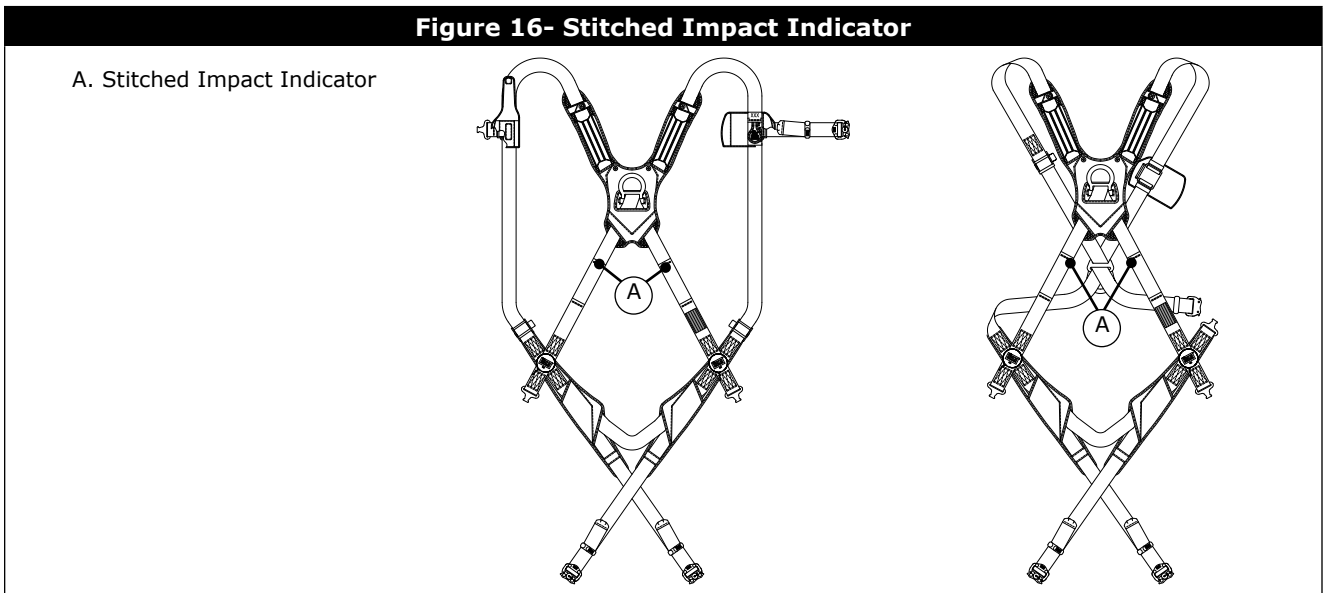

## 6.0 MAINTENANCE, SERVICING, AND STORAGE

**6.1 WASHING INSTRUCTIONS:** Washing procedures for the ExoFit NEX™ Full Body Harness are as follows:

**Step 1.** Spot clean the ExoFit NEX™ full body harness with water and a mild soap solution.

**IMPORTANT:** Use a bleach-free detergent when washing the harness and pads. Fabric softener or dryer sheets **SHOULD NOT** be used when laundering and drying the harness and pads.

**Step 2.** Water temperature for wash and rinse must not exceed 160° F (70° C).

**Step 3.** The harness and pads may be air dried or tumble dried on low heat not exceeding 200° F (90° C).

**NOTE:** More information on cleaning is available from Capital Safety. If you have questions concerning the condition of your harness, or have any doubt about putting it into service, contact Capital Safety.

**6.2 ADDITIONAL MAINTENANCE AND SERVICING:** Additional maintenance and servicing procedures must be completed by a factory authorized service center. Authorization must be in writing. Do not attempt to disassemble the unit.

**6.3 STORAGE:** Store the ExoFit NEX™ Full Body Harness in a cool, dry, clean environment out of direct sunlight. Avoid areas where chemical vapors may exist. Thoroughly inspect the full body harness after extended storage.

## 7.0 SPECIFICATIONS

### 7.1 PERFORMANCE:

- **Maximum Free Fall Distance:** No greater than 6 ft (1.8 m), per federal law and ANSI Z359.1.

**NOTE:** Harness is acceptable for use with free fall distances exceeding 6 feet (1.8 m) if used with appropriate connecting system.

- **Maximum Arresting Force:** 1,800 lbs. (13 kN)
- **Maximum Capacity:**
  - 420 lbs. (191 kg) per OSHA
  - 310 lbs. (141 kg) per ANSI Z359.1
  - 352 lbs. (160 kg) per CSA Z259.10-06
- **Approximate Weight:**
  - Harness only:* 3 lbs. (1.4 kg)
  - Harness with Side D-rings:* Add 1/2 lb. (.23 kg)
  - Harness with Front D-ring:* Add 1/4 lb. (.11 kg)
  - Harness with Back Pad or Belt:* Add 1 lb. (.45 kg)

### 7.2 MATERIALS:

- **Webbing Materials:** 6,000 lbs (27 kN) Polyester; 7,000 lbs (31 kN) Tensile Strength Nylon; 7,000 lbs Tensile Strength Nomex<sup>4</sup> covered Kevlar<sup>4</sup>
- **Pad and Label Cover Materials:**
  - Blend of Nylon and Polyester.
  - All outer fabric is Nomex and Kevlar blend fabric. (Arc Flash models only)
  - Fire Resistant Hook and Loop Fasteners. (Arc Flash models only)
- **Optional Accessories:**
  - Hip Pad with side D-rings
  - Nomex<sup>®</sup> covered Kevlar<sup>®</sup> webbing
  - Non-sparking/ Non-conductive PVC coated hardware
  - Arc-rated hip, leg, and back pads
  - Polyurethane coated, arc-rated dorsal web loop

- **7.3 STANDARDS:** When installed and used per the requirements and recommendations in the manual, the ExoFit NEX™ Full Body Harness meets local, state, and federal requirements defined in Section 1.2.

<sup>4</sup> ®: Nomex<sup>®</sup> and Kevlar<sup>®</sup> are registered trademarks of DuPont.



## 8.0 LABELING

The following labels must be securely attached and fully legible:

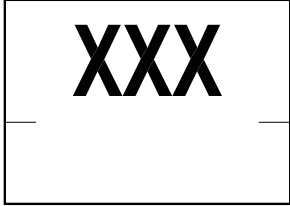
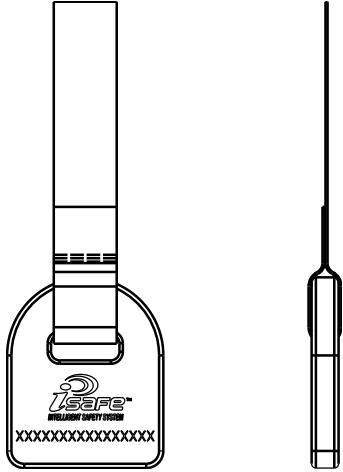
All Models																																															
																																															
ANSI Models	CSA Models																																														
<div style="border: 1px solid black; padding: 5px;"> <p style="font-size: small; margin: 0;">9503020 Rev. C</p> <p style="margin: 0;"><b>PRODUCT COMPLIANCE</b> THIS PRODUCT COMPLIES WITH THE FOLLOWING STANDARDS ONLY IF MARKED WITH THE CORRESPONDING LETTER CODE UNDER "STDS" SECTION BELOW.</p> <table style="width: 100%; font-size: x-small; margin: 0;"> <tr> <td>A = ANSI Z359.1</td> <td>B = OSHA</td> </tr> <tr> <td>C = ANSI A10.32-2004</td> <td>D = ASTM F887-11</td> </tr> <tr> <td>E = ANSI Z359.3</td> <td>F = ANSI Z359.4</td> </tr> </table> <p style="margin: 0;"><b>MFRD</b>(YR/MO):    <b>LOT</b>:    <b>MODEL NO</b>:    <b>STDS</b>:</p> </div> <div style="border: 1px solid black; padding: 5px; margin-top: 5px;"> <p style="text-align: center; font-size: small; margin: 0;">SERIAL NO.: SEE RFID TAG IN CLEAR POUCH</p> <table style="width: 100%; border-collapse: collapse; font-size: x-small;"> <tr> <td style="width: 5%; text-align: center; vertical-align: middle;">INITIAL</td> <td style="width: 10%; border: 1px solid black;"> </td> <td style="width: 10%; border: 1px solid black;"> </td> <td style="width: 10%; border: 1px solid black;"> </td> <td style="width: 10%; border: 1px solid black;"> </td> <td style="width: 10%; border: 1px solid black;"> </td> <td style="width: 10%; border: 1px solid black;"> </td> <td style="width: 10%; border: 1px solid black;"> </td> <td style="width: 10%; border: 1px solid black;"> </td> <td style="width: 10%; border: 1px solid black;"> </td> </tr> <tr> <td style="text-align: center; vertical-align: middle;">DATE</td> <td style="border: 1px solid black;"> </td> <td style="border: 1px solid black;"> </td> <td style="border: 1px solid black;"> </td> <td style="border: 1px solid black;"> </td> <td style="border: 1px solid black;"> </td> <td style="border: 1px solid black;"> </td> <td style="border: 1px solid black;"> </td> <td style="border: 1px solid black;"> </td> <td style="border: 1px solid black;"> </td> </tr> </table> <p style="text-align: center; font-size: small; margin: 0;"><b>INSPECTION LOG</b>      DO NOT REMOVE THIS LABEL</p> </div>	A = ANSI Z359.1	B = OSHA	C = ANSI A10.32-2004	D = ASTM F887-11	E = ANSI Z359.3	F = ANSI Z359.4	INITIAL										DATE										<div style="border: 1px solid black; padding: 5px;"> <p style="font-size: small; margin: 0;">9502095 REV A</p> <p style="text-align: center; margin: 0;"><b>INSPECTION LOG</b> RELEVÉ D'INSPECTION</p> <p style="font-size: x-small; margin: 0;">SERIAL NO./NUMÉRO DE SÉRIE: SEE RFID TAG IN CLEAR POUCH VOIR L'ÉTIQUETTE DE RFID DANS LA POCHE TRANSPARENTE</p> <table style="width: 100%; border-collapse: collapse; font-size: x-small;"> <tr> <td style="width: 5%; text-align: center; vertical-align: middle;">INITIAL</td> <td style="width: 10%; border: 1px solid black;"> </td> <td style="width: 10%; border: 1px solid black;"> </td> <td style="width: 10%; border: 1px solid black;"> </td> <td style="width: 10%; border: 1px solid black;"> </td> <td style="width: 10%; border: 1px solid black;"> </td> <td style="width: 10%; border: 1px solid black;"> </td> <td style="width: 10%; border: 1px solid black;"> </td> <td style="width: 10%; border: 1px solid black;"> </td> <td style="width: 10%; border: 1px solid black;"> </td> </tr> <tr> <td style="text-align: center; vertical-align: middle;">DATE</td> <td style="border: 1px solid black;"> </td> <td style="border: 1px solid black;"> </td> <td style="border: 1px solid black;"> </td> <td style="border: 1px solid black;"> </td> <td style="border: 1px solid black;"> </td> <td style="border: 1px solid black;"> </td> <td style="border: 1px solid black;"> </td> <td style="border: 1px solid black;"> </td> <td style="border: 1px solid black;"> </td> </tr> </table> <p style="text-align: center; font-size: small; margin: 0;"><b>MFRD/LOT/FABR. LOT:</b> (YR/MO)/(AAMM)      <b>MODEL NO./MODÈLE</b></p> <p style="font-size: x-small; margin: 0; text-align: right;">DO NOT REMOVE THIS LABEL NE PAS ENLEVER CETTE ÉTIQUETTE</p> </div>	INITIAL										DATE									
A = ANSI Z359.1	B = OSHA																																														
C = ANSI A10.32-2004	D = ASTM F887-11																																														
E = ANSI Z359.3	F = ANSI Z359.4																																														
INITIAL																																															
DATE																																															
INITIAL																																															
DATE																																															
<div style="border: 1px solid black; padding: 5px;"> <p style="font-size: small; margin: 0;">9500340 Rev. G</p> <p style="font-size: x-small; margin: 0;"><b>⚠ WARNING</b> MANUFACTURER'S INSTRUCTIONS MUST BE READ AND UNDERSTOOD PRIOR TO USE. INSTRUCTIONS SUPPLIED WITH THIS PRODUCT AT TIME OF SHIPMENT MUST BE FOLLOWED. FAILURE TO DO SO COULD RESULT IN SERIOUS INJURY OR DEATH. CONTACT DBI-SALA IF INSTRUCTION SHEET IS NEEDED. INSPECT BEFORE EACH USE. DO NOT USE IF WEAR OR DAMAGE IS PRESENT. THIS BODY HARNESS IS INTENDED TO BE USED TO ARREST THE MOST SEVERE FREE FALLS. ITEMS SUBJECTED TO FALL ARREST OR IMPACT FORCES MUST BE IMMEDIATELY REMOVED FROM SERVICE AND DESTROYED. CONNECTING SNAP AND D-RING MUST BE COMPATIBLE IN SIZE, SHAPE, AND STRENGTH. THIS ITEM IS NOT FLAME OR HEAT RESISTANT. REPAIRS ONLY TO BE PERFORMED BY DBI-SALA. EQUIPMENT MODIFICATION OR MISUSE VOIDS WARRANTY.</p> </div> <div style="border: 1px solid black; padding: 5px; margin-top: 5px;"> <p style="font-size: small; margin: 0;"><b>DBI-SALA</b> BODY HARNESS POLYESTER WEB</p> <p style="font-size: small; margin: 0;">CAPACITY: 420 LBS.</p> <p style="font-size: x-small; margin: 0;"><b>⚠ WARNING</b> DO NOT EXCEED CAPACITY OF THIS OR OTHER SYSTEM COMPONENTS. CAPACITY IS THE COMBINED WEIGHT FOR WHICH THE COMPONENT IS DESIGNED TO BE USED. COMBINED WEIGHT INCLUDES THE USER'S BODY WEIGHT, CLOTHING, TOOLS, AND ANY OBJECTS CARRIED. CONTACT DBI-SALA FOR MORE INFORMATION</p> <p style="font-size: x-small; margin: 0;">www.capitalsafety.com USA: (800) 328-6146</p> <p style="font-size: x-small; margin: 0;">DO NOT REMOVE LABEL MADE IN XXXX</p> </div>	<div style="border: 1px solid black; padding: 5px;"> <p style="font-size: small; margin: 0;">9500473 REV D</p> <p style="font-size: x-small; margin: 0;"><b>⚠ WARNING</b> MANUFACTURER'S INSTRUCTIONS MUST BE READ AND UNDERSTOOD PRIOR TO USE. INSTRUCTIONS SUPPLIED WITH THIS PRODUCT AT TIME OF SHIPMENT MUST BE FOLLOWED. FAILURE TO DO SO COULD RESULT IN SERIOUS INJURY OR DEATH. CONTACT CAPITAL SAFETY IF INSTRUCTION SHEET IS NEEDED. INSPECT BEFORE EACH USE. REMOVE FROM SERVICE AFTER FALL ARREST. REMOVE FROM SERVICE IF WEAR DAMAGE IS PRESENT DURING INSPECTION. MAKE ONLY COMPATIBLE CONNECTIONS. DO NOT ALTER OR REPAIR HARNESS.</p> <p style="font-size: x-small; margin: 0;"><b>⚠ AVERTISSEMENTS</b> LES INSTRUCTIONS DU FABRIQUANT DOIVENT ÊTRE LUES ET COMPRISÉES PRÉALABLEMENT À L'UTILISATION. LES INSTRUCTIONS FOURNIES AVEC CE PRODUIT AU MOMENT DE L'EXPÉDITION DOIVENT ÊTRE SUIVIES. NÉGLIGER CES RECOMMANDATIONS PEUT ENTRAÎNER DES BLESSURES GRAVES, VOIRE MORTELLES. CONTACTER CAPITAL SAFETY EN CAS DE BESOIN DE NOTICE. INSPECTER AVANT CHAQUE UTILISATION. METTRE HORS SERVICE APRÈS L'ARRÊT D'UNE CHUTE. METTRE HORS SERVICE SI L'INSPECTION RÉVÈLE DES DOMMAGES DUS À L'USURE. EFFECTUER SEULEMENT DES FIXATIONS COMPATIBLES. NE PAS MODIFIER OU RÉPARER LE HARNAIS.</p> </div> <div style="border: 1px solid black; padding: 5px; margin-top: 5px;"> <p style="font-size: small; margin: 0;"><b>DBI-SALA</b> BODY HARNESS/Harnais de sécurité POLYESTER WEB/Sangle: polyester SIZE/GRANDEUR: SEE LABEL/ DO NOT REMOVE THIS LABEL/ Ne pas enlever cette étiquette</p> <p style="font-size: small; margin: 0;">www.capitalsafety.com (800) 328-6146 MADE IN U.S.A.</p> <p style="text-align: center; font-size: x-small; margin: 0;"> CSA STANDARD Z259.10-06</p> <p style="font-size: small; margin: 0;">HARNESS CLASSIFICATION/ Classe de Harnais</p> </div>																																														

**ANSI Models**

**CSA Models**

9506051 REV A

**WARNING** MANUFACTURER'S INSTRUCTIONS MUST BE READ AND UNDERSTOOD PRIOR TO USE. INSTRUCTIONS SUPPLIED WITH THIS PRODUCT AT TIME OF SHIPMENT MUST BE FOLLOWED. FAILURE TO DO SO COULD RESULT IN SERIOUS INJURY OR DEATH. CONTACT DBI-SALA IF INSTRUCTION SHEET IS NEEDED. INSPECT BEFORE EACH USE. DO NOT USE IF WEAR OR DAMAGE IS PRESENT. THIS BODY HARNESS IS INTENDED TO BE USED TO ARREST THE MOST SEVERE FREE FALLS. ITEMS SUBJECTED TO FALL ARREST OR IMPACT FORCES MUST BE IMMEDIATELY REMOVED FROM SERVICE AND DESTROYED. CONNECTING SNAP AND D-RING MUST BE COMPATIBLE IN SIZE, SHAPE AND STRENGTH. REPAIRS ONLY TO BE PERFORMED BY DBI-SALA. EQUIPMENT MODIFICATION OR MISUSE VOIDS WARRANTY.



BODY HARNESS.  
CAPACITY: 420 LBS.  
NOMEX/KEVLAR WEB

www.capitalsafety.com  
Capital Safety  
Red Wing, MN, USA  
+1-800-328-6146

DO NOT REMOVE THIS LABEL

USER IDENTIFICATION  
MARK LABEL WITH  
PERMANENT MARKER

9503011 REV B  
U.S. PATENT No. 6,668,434

- A - BACK D-RING IS FOR FALL ARREST AND RESCUE.
- B - FRONT D-RING (IF PRESENT) IS FOR POSITIONING, LADDER CLIMBING, OR FALL ARREST (2 FT MAXIMUM FREEFALL). USE SELF-LOCKING SNAPS ONLY.
- C - SIDE D-RINGS (IF PRESENT) ARE FOR POSITIONING.
- D - SHOULDER D-RINGS (IF PRESENT) ARE FOR RESCUE ONLY. DO NOT USE FOR OTHER PURPOSES. USE SELF-LOCKING SNAPS ONLY.

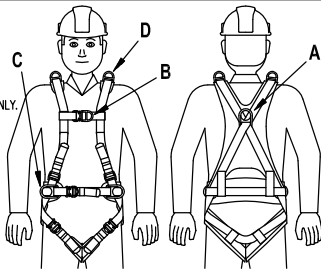

SEE INSTRUCTIONS FOR MORE DETAILS.

**Vest Style Harness**

USER IDENTIFICATION  
MARK LABEL WITH  
PERMANENT MARKER

9503007 REV B

- A - FRONT D-RING (IF PRESENT) IS FOR POSITIONING, LADDER CLIMBING, OR FALL ARREST (2 FT. MAXIMUM FREEFALL).
- B - BACK D-RING IS FOR FALL ARREST AND RESCUE.
- C - SIDE D-RINGS (IF PRESENT) ARE FOR POSITIONING.

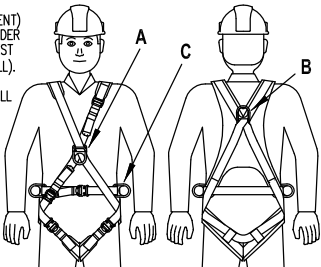

SEE INSTRUCTIONS FOR MORE DETAILS.  
U.S. PAT. NO. RE35,028  
CAN. PAT. NO. 2080643.

**Cross-Over Style Harness**

USER IDENTIFICATION/  
IDENTIFICATION DE L'UTILISATEUR  
MARK LABEL WITH PERMANENT  
MARKER/MARQUER L'ÉTIQUETTE AVEC  
UN MARQUEUR PERMANENT.

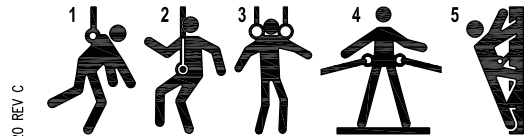

9503020 REV C

- 1) FALL ARREST, CLASS A, AND RESCUE/ARRÊT DES CHUTES ET SAUVEtage, CLASSE A (ANSI Z359.1 & ANSI Z359.4) ET SAUVEtage, CLASSE A (ANSI Z359.1 & ANSI Z359.4)
  - 2) SUSPENSION OR CONTROLLED DESCENT/ SUSPENSION OU DESCENTE CONTRÔLÉE CLASS D/CLASSE D
  - 3) LIMITED ACCESS/RESCUE/ACCES LIMITE/SAUVEtage CLASS E/CLASSE E (ANSI Z359.4)
  - 4) WORK POSITIONING/MAINTEN EN POSITION DE TRAVAIL CLASS P/CLASSE P (ANSI Z359.3)
  - 5) LADDER ACCESS/ACCES AUX ÉCHELLES CLASS L/CLASSE L (ANSI Z359.1)
- \* FOR SYSTEMS MEETING/POUR LES SYSTEMES SOUS LA NORME ANSI Z359.1 - MAY BE USED FOR FALL ARREST (2 FT. MAXIMUM FREEFALL)/PEUT ÊTRE UTILISÉ POUR L'ARRÊT DES CHUTES (2 FT. (0.6m) DE CHUTE LIBRE MAXIMUM)
- † OR, AS APPLICABLE - MAY BE USED FOR FALL ARREST./PEUT ÊTRE UTILISÉ POUR L'ARRÊT DES CHUTES
- SEE INSTRUCTIONS FOR MORE DETAILS/VOIR LES INSTRUCTIONS POUR PLUS DÉTAILS

# 9.0 INSPECTION AND MAINTENANCE LOG

<b>SERIAL NUMBER:</b>			
<b>MODEL NUMBER:</b>			
<b>DATE PURCHASED:</b>			<b>DATE OF FIRST USE:</b>

<b>INSPECTION DATE</b>	<b>INSPECTION ITEMS NOTED</b>	<b>CORRECTIVE ACTION</b>	<b>MAINTENANCE PERFORMED</b>
Approved By:			
Approved By:			
Approved By:			
Approved By:			
Approved By:			
Approved By:			
Approved By:			
Approved By:			
Approved By:			
Approved By:			
Approved By:			
Approved By:			
Approved By:			
Approved By:			
Approved By:			
Approved By:			
Approved By:			
Approved By:			
Approved By:			





### ANSI Models

1100381	1113014	1113090	1113191	1113281	1113361	1113426	1113517	1113586	1113655
1100382	1113014H	1113091	1113191H	1113282	1113362	1113427	1113518	1113587	1113656
1100383	1113015	1113092	1113192	1113285	1113363	1113428	1113519	1113588	1113657
1100384	1113016	1113093	1113192H	1113286	1113364	1113434	1113520	1113589	1113658
1100385	1113016C	1113094	1113193	1113287	1113365	1113435	1113521	1113590	1113659
1100386	1113018	1113095	1113193H	1113288	1113366	1113436	1113522	1113591	1113660
1100387	1113019	1113096	1113194	1113290	1113367	1113437	1113523	1113592	1113661
1100388	1113020	1113097	1113195	1113291	1113368	1113438	1113524	1113593	1113662
1100397	1113021	1113098	1113196	1113291H	1113369	1113439	1113525	1113594	1113663
1100398	1113022	1113100	1113197	1113292	1113370	1113445	1113526	1113595	1113664
1100920	1113023	1113103	1113198	1113292H	1113371	1113446	1113527	1113596	1113665
1100921	1113024	1113105	1113199	1113293	1113372	1113447	1113528	1113597	1113666
1100922	1113025	1113106	1113200	1113293H	1113373	1113448	1113529	1113598	1113667
1100923	1113026	1113106H	1113201	1113294	1113374	1113459	1113530	1113599	1113668
1101739	1113027	1113109	1113202	1113295	1113375	1113460	1113531	1113600	1113669
1101742	1113028	1113109H	1113203	1113296	1113375H	1113461	1113532	1113601	1113670
1101743	1113030	1113112	1113204	1113297	1113376	1113462	1113533	1113602	1113671
1101744	1113031	1113115	1113205	1113298	1113376H	1113463	1113534	1113603	1113672
1101749	1113032	1113118	1113206	1113303	1113377	1113464	1113535	1113604	1113673
1101759	1113033	1113120	1113207	1113305	1113377H	1113465	1113536	1113605	1113674
1101919	1113034	1113121	1113208	1113306	1113378	1113466	1113537	1113606	1113675
1101921	1113036	1113124	1113220	1113307	1113378H	1113467	1113538	1113607	1113676
1101922	1113037	1113124H	1113225	1113308	1113379	1113468	1113539	1113608	1113677
1101923	1113038	1113127	1113226	1113309	1113380	1113469	1113540	1113609	1113678
1101924	1113039	1113130	1113227	1113310	1113381	1113470	1113541	1113610	1113679
1102016	1113040	1113133	1113228	1113311	1113382	1113471	1113542	1113611	1113680
1102017	1113043	1113135	1113229	1113312	1113383	1113472	1113543	1113612	1113681
1102018	1113045	1113136	1113230	1113313	1113384	1113473	1113544	1113613	1113682
1102019	1113046	1113137	1113231	1113314	1113385	1113474	1113545	1113614	1113683
1102023	1113046H	1113138	1113232	1113315	1113386	1113475	1113546	1113615	1113684
1102705	1113049	1113139	1113233	1113316	1113387	1113476	1113547	1113616	1113685
1102706	1113049H	1113140	1113234	1113317	1113388	1113477	1113548	1113617	1113686
1102707	1113052	1113142	1113240	1113318	1113389	1113478	1113549	1113618	1113687
1102708	1113052H	1113143	1113241	1113319	1113390	1113479	1113550	1113619	1113688
1102709	1113055	1113145	1113242	1113320	1113391	1113480	1113551	1113620	1113689
1103070	1113055H	1113148	1113243	1113321	1113392	1113481	1113552	1113621	1113690
1103071	1113058	1113150	1113244	1113322	1113393	1113482	1113553	1113622	1113691
1103072	1113058H	1113151	1113245	1113323	1113394	1113483	1113554	1113623	1113692
1103072H	1113060	1113151H	1113246	1113324	1113395	1113484	1113555	1113624	1113693
1103073	1113061	1113154	1113247	1113325	1113396	1113485	1113556	1113625	1113694
1103073H	1113061H	1113154H	1113248	1113326	1113397	1113486	1113557	1113626	1113695
1103074	1113064	1113157	1113249	1113327	1113398	1113487	1113558	1113627	1113696
1103084	1113064H	1113157H	1113250	1113328	1113399	1113490	1113559	1113628	1113697
1103085	1113067	1113160	1113251	1113329	1113400	1113491	1113560	1113629	1113698
1103086	1113067H	1113160H	1113252	1113330	1113401	1113492	1113561	1113630	1113703
1103087	1113068	1113162	1113253	1113331	1113402	1113493	1113562	1113631	1113704
1103088	1113069	1113163	1113254	1113332	1113403	1113494	1113563	1113632	1113705
1103089	1113070	1113164	1113255	1113333	1113404	1113495	1113564	1113633	1113706
1103094	1113070H	1113165	1113256	1113334	1113405	1113496	1113565	1113634	1113707
1103095	1113071	1113166	1113257	1113335	1113406	1113497	1113566	1113635	1113708
1113000	1113072	1113167	1113258	1113336	1113407	1113498	1113567	1113636	1113709
1113001	1113073	1113168	1113259	1113337	1113408	1113499	1113568	1113637	1113710
1113001H	1113073H	1113169	1113260	1113338	1113409	1113500	1113569	1113638	1113711
1113004	1113075	1113170	1113261	1113339	1113410	1113501	1113570	1113639	1113712
1113004H	1113076	1113171	1113262	1113345	1113411	1113502	1113571	1113640	1113713
1113007	1113076H	1113172	1113263	1113346	1113412	1113503	1113572	1113641	1113714
1113007H	1113077	1113173	1113264	1113347	1113413	1113504	1113573	1113642	1113715
1113008	1113078	1113180	1113269	1113348	1113414	1113505	1113574	1113643	1113716
1113008H	1113079	1113181	1113270	1113350	1113415	1113506	1113575	1113644	1113717
1113009	1113079H	1113182	1113271	1113351	1113416	1113507	1113576	1113645	1113718
1113009H	1113080	1113183	1113272	1113352	1113417	1113508	1113577	1113646	1113719
1113010	1113081	1113184	1113273	1113353	1113418	1113509	1113578	1113647	1113720
1113010H	1113082	1113185	1113274	1113354	1113419	1113510	1113579	1113648	
1113011	1113082H	1113186	1113275	1113355	1113420	1113511	1113580	1113649	
1113011H	1113083	1113187	1113276	1113356	1113421	1113512	1113581	1113650	
1113012	1113085	1113188	1113277	1113357	1113422	1113513	1113582	1113651	
1113012H	1113085H	1113189	1113278	1113358	1113423	1113514	1113583	1113652	
1113013	1113088	1113190	1113279	1113359	1113424	1113515	1113584	1113653	
1113013H	1113088H	1113190H	1113280	1113360	1113425	1113516	1113585	1113654	

**CSA Models**

1103070C	1113060C	1113136C	1113217	1113326C	1113455	1113566C	1113614C	1113681C	1122224C
1103071C	1113061C	1113139C	1113218	1113327C	1113456	1113567C	1113615C	1113682C	1123121C
1103072C	1113061CH	1113142C	1113219	1113328C	1113457	1113568C	1113616C	1113683C	1123122C
1103073C	1113064C	1113145C	1113220C	1113329C	1113458	1113569C	1113617C	1113684C	1123123C
1103074C	1113064CH	1113148C	1113221C	1113330C	1113459C	1113570C	1113644C	1113685C	1123124C
1103085C	1113067C	1113150C	1113222C	1113331C	1113460C	1113571C	1113645C	1113686C	1123125C
1103086C	1113067CH	1113151C	1113223C	1113332C	1113467C	1113572C	1113646C	1113687C	1123126C
1103087C	1113070C	1113152C	1113224C	1113333C	1113468C	1113573C	1113647C	1113688C	1123221C
1103088C	1113070CH	1113153C	1113235C	1113334C	1113509C	1113574C	1113648C	1113689C	1123222C
1103089C	1113073C	1113154C	1113236C	1113335C	1113510C	1113575C	1113649C	1113690C	1123223C
1113000C	1113075C	1113155C	1113237C	1113336C	1113511C	1113576C	1113650C	1113691C	1123224C
1113001C	1113076C	1113156C	1113238C	1113337C	1113512C	1113577C	1113651C	1113692C	1123225C
1113001CH	1113079C	1113157C	1113239C	1113338C	1113513C	1113578C	1113652C	1113693C	1123226C
1113002C	1113082C	1113160C	1113264	1113339C	1113514C	1113579C	1113653C	1113694C	1124123C
1113003C	1113085C	1113163C	1113265C	1113340C	1113515C	1113580C	1113654C	1113695C	1124124C
1113004C	1113088C	1113174	1113266C	1113341C	1113516C	1113581C	1113655C	1113696C	1124125C
1113004CH	1113090C	1113175	1113267C	1113345C	1113517C	1113582C	1113656C	1113697C	1124126C
1113005C	1113090CH	1113176	1113268C	1113346C	1113518C	1113590C	1113657C	1113698C	1124127C
1113006C	1113091C	1113177	1113290C	1113347C	1113519C	1113591C	1113658C	1113699C	1124223C
1113007C	1113091CH	1113178	1113291C	1113348C	1113520C	1113592C	1113659C	1113700C	1124224C
1113007CH	1113094C	1113179	1113292C	1113370C	1113521C	1113593C	1113660C	1113701C	1124225C
1113010C	1113094CH	1113190C	1113293C	1113371C	1113522C	1113594C	1113661C	1113702C	1124226C
1113013C	1113097C	1113190CH	1113295C	1113372C	1113523C	1113595C	1113662C	1121118C	1124227C
1113015C	1113100C	1113191C	1113296C	1113373C	1113524C	1113596C	1113663C	1121119C	1125125C
1113019C	1113103C	1113191CH	1113297C	1113385C	1113525C	1113597C	1113664C	1121120C	1125126C
1113022C	1113105C	1113192C	1113298C	1113386C	1113526C	1113598C	1113665C	1121218C	1125127C
1113025C	1113106C	1113192CH	1113299C	1113387C	1113527C	1113599C	1113666C	1121219C	1125128C
1113028C	1113109C	1113193C	1113300C	1113388C	1113528C	1113600C	1113667C	1121220C	1125225C
1113029C	1113112C	1113193CH	1113301C	1113430C	1113529C	1113601C	1113668C	1122118C	1125226C
1113030C	1113115C	1113194C	1113302C	1113431C	1113530C	1113602C	1113669C	1122119C	1125227C
1113031C	1113118C	1113195C	1113315C	1113432C	1113531C	1113603C	1113670C	1122120C	1125228C
1113034C	1113120C	1113196C	1113316C	1113433C	1113532C	1113604C	1113671C	1122121C	1126127C
1113037C	1113121C	1113197C	1113317C	1113440C	1113557C	1113605C	1113672C	1122122C	1126128C
1113040C	1113124C	1113199C	1113318C	1113441C	1113558C	1113606C	1113673C	1122123C	1126129C
1113043C	1113125C	1113210	1113319C	1113442C	1113559C	1113607C	1113674C	1122124C	1126130C
1113045C	1113126C	1113211	1113320C	1113449	1113560C	1113608C	1113675C	1122218C	1126227C
1113046C	1113127C	1113212	1113321C	1113450	1113561C	1113609C	1113676C	1122219C	1126228C
1113049C	1113128C	1113213	1113322C	1113451	1113562C	1113610C	1113677C	1122220C	1126229C
1113052C	1113130C	1113214	1113323C	1113452	1113563C	1113611C	1113678C	1122221C	1126230C
1113055C	1113133C	1113215	1113324C	1113453	1113564C	1113612C	1113679C	1122222C	
1113058C	1113135C	1113216	1113325C	1113454	1113565C	1113613C	1113680C	1122223C	

## LIMITED LIFETIME WARRANTY

**Warranty to End User:** D B Industries, Inc., dba CAPITAL SAFETY USA ("CAPITAL SAFETY") warrants to the original end user ("End User") that its products are free from defects in materials and workmanship under normal use and service. This warranty extends for the lifetime of the product from the date the product is purchased by the End User, in new and unused condition, from a CAPITAL SAFETY authorized distributor. CAPITAL SAFETY'S entire liability to End User and End User's exclusive remedy under this warranty is limited to the repair or replacement in kind of any defective product within its lifetime (as CAPITAL SAFETY in its sole discretion determines and deems appropriate). No oral or written information or advice given by CAPITAL SAFETY, its distributors, directors, officers, agents or employees shall create any different or additional warranties or in any way increase the scope of this warranty. CAPITAL SAFETY will not accept liability for defects that are the result of product abuse, misuse, alteration or modification, or for defects that are due to a failure to install, maintain, or use the product in accordance with the manufacturer's instructions.

CAPITAL SAFETY'S WARRANTY APPLIES ONLY TO THE END USER. THIS WARRANTY IS THE ONLY WARRANTY APPLICABLE TO OUR PRODUCTS AND IS IN LIEU OF ALL OTHER WARRANTIES AND LIABILITIES, EXPRESSED OR IMPLIED. CAPITAL SAFETY EXPRESSLY EXCLUDES AND DISCLAIMS ANY IMPLIED WARRANTIES OF MERCHANTABILITY OR FITNESS FOR A PARTICULAR PURPOSE, AND SHALL NOT BE LIABLE FOR INCIDENTAL, PUNITIVE OR CONSEQUENTIAL DAMAGES OF ANY NATURE, INCLUDING WITHOUT LIMITATION, LOST PROFITS, REVENUES, OR PRODUCTIVITY, OR FOR BODILY INJURY OR DEATH OR LOSS OR DAMAGE TO PROPERTY, UNDER ANY THEORY OF LIABILITY, INCLUDING WITHOUT LIMITATION, CONTRACT, WARRANTY, STRICT LIABILITY, TORT (INCLUDING NEGLIGENCE) OR OTHER LEGAL OR EQUITABLE THEORY.



The Ultimate in Fall Protection

### **CSG USA & Latin America**

3833 SALA Way  
Red Wing, MN 55066-5005  
Toll Free: 800.328.6146  
Phone: 651.388.8282  
Fax: 651.388.5065  
solutions@capitalsafety.com

### **CSG Canada**

260 Export Boulevard  
Mississauga, ON L5S 1Y9  
Phone: 905.795.9333  
Toll-Free: 800.387.7484  
Fax: 888.387.7484  
info.ca@capitalsafety.com

### **CSG Northern Europe**

5a Merse Road  
North Moons, Moat  
Reditch, Worcestershire, UK  
B98 9HL  
Phone: + 44 (0)1527 548 000  
Fax: + 44 (0)1527 591 000  
csgne@capitalsafety.com

### **CSG EMEA (Europe, Middle East, Africa)**

Le Broc Center  
Z.I. 1ère Avenue  
5600 M B.P. 15 06511  
Carros  
Le Broc Cedex  
France  
Phone: + 33 4 97 10 00 10  
Fax: + 33 4 93 08 79 70  
information@capitalsafety.com

### **CSG Australia & New Zealand**

95 Derby Street  
Silverwater  
Sydney NSW 2128  
AUSTRALIA  
Phone: +(61) 2 8753 7600  
Toll-Free : 1 800 245 002 (AUS)  
Toll-Free : 0800 212 505 (NZ)  
Fax: +(61) 2 8753 7603  
sales@capitalsafety.com.au

### **CSG Asia**

*Singapore:*  
16S, Enterprise Road  
Singapore 627666  
Phone: +65 - 65587758  
Fax: +65 - 65587058  
inquiry@capitalsafety.com

### *Shanghai:*

Rm 1406, China Venturetech Plaza  
819 Nan Jing Xi Rd,  
Shanghai 200041, P R China  
Phone: +86 21 62539050  
Fax: +86 21 62539060

[www.capitalsafety.com](http://www.capitalsafety.com)

