



**Manufacturing Premium
Surface Preparation & Air Filtration
Equipment**

Your One Stop Source for Surface Preparation and Air Filtration Equipment

Durable and Dependable

Novatek. It's the name you can rely on for surface preparation and air filtration. All equipment supplied by Novatek is designed to be durable, dependable, and perform efficiently.

High Performance and Industry Tested

Novatek supplies only the finest industrial surface preparation & air filtration equipment available. All Novatek products are manufactured to the highest quality standards to ensure years of trouble free operation. Whether you are removing coatings, rust, scale, concrete, sheet goods or virtually any other material, Novatek has the product to get the job done.



High Performance, Low Emission

Our low emission levels meet the federal emission standards and the requirements of the EPA and OSHA. In tests conducted by an independent lab on lead based coating removal, our systems demonstrated the ability to stay below the Personal Exposure Levels of 50 micrograms per cubic meters and Action Levels of 30 micrograms per cubic meter in both controlled environments and field studies.



Wide Variety, Versatile and Cost Effective

The Novatek tools & equipment range from hand held machines for spot cleaning, portable air filtration for dust control, to large "walk behind" concrete grinders and scarifiers. Novatek can custom tailor a system that will maximize production and provide the most cost-effective method available. All equipment provided by Novatek has the ability to be shrouded for dustless applications. For your next coatings removal / surface preparation project be sure to contact Novatek for a free on-site demonstration. **" We let the tools do the talking !"**



If you would like more information about the advantages of working with Novatek products, please call us toll free at

1-866-563-7800



- TABLE OF CONTENTS -

STANDARD EQUIPMENT

Needle Scalers	4 – 5
Long Reach Scrapers	6
Long Reach Breaker	7
Pole Scabbler	7
Chisels & Scrapers	8– 9
Scaling Hammers	10-11

FLOOR EQUIPMENT

SF11 – Scale Force 11	12
MHS11 – Multi Head Scabbler	13
TFP – Floor Scarifiers & Cutters	14–15

VACUUM SHROUDED EQUIPMENT

Shrouded Needle Scalers	16-17
PPT – Peening Prep Tools	18-19
Shrouded Right Angle Grinders	20
Shrouded Mini Grinders	21
Shrouded Scaling Hammers	22-23
Shrouds – Grinder & Drill	24-25



AIR FILTRATION EQUIPMENT

Duct-2-Go - Ventilation Duct System	25
Duravent - Ventilation Machine	26
NovAir 1000 - Negative Air Machine	27
NovAir 2000 - Negative Air Machine	28

INFRARED TILE MACHINES

NovaStrip 1026 – Infrared Heat Machine	29
NovaStrip 378 – Infrared Heat Machine	30
EcoStrip 100 – Infrared Heat Machine	30

HEPA VACUUMS

Backpack Vacuums	31
Floor Vacuums	31
Multi Tool Vacuums	32

MARINE EQUIPMENT

Trident Neptune – Deck Scaler	33
Hydrflex – Hold Cleaning Equipment	34

VACUUM BLASTING EQUIPMENT

CBS – Contained Blast System	35
------------------------------	----



TM

NEEDLE SCALERS

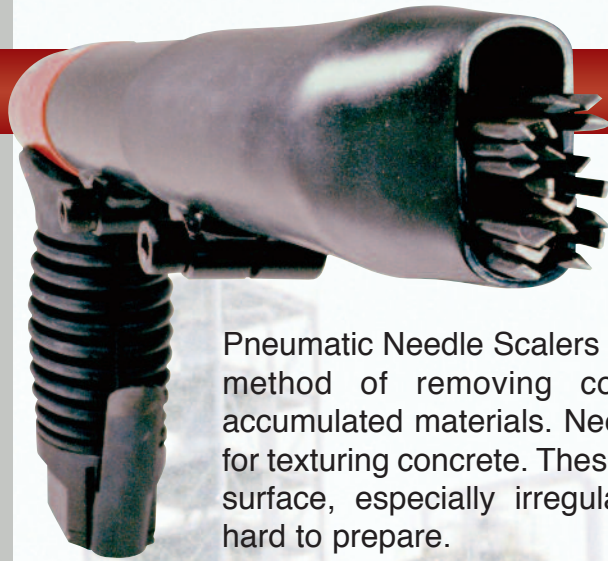

Pneumatic Needle Scalers provide a thorough and effective method of removing coatings, corrosion and other accumulated materials. Needle scalers are also often used for texturing concrete. These scalers will work on almost any surface, especially irregular surfaces that are otherwise hard to prepare.

Commonly used as chisel scalers for brick raking, chipping and splitting applications, Needle Scalers convert to Chisel Scalers in seconds.

Please consult Novatek for further details on our range of low vibration Needle/Chisel Scalers.



All Needle Scalers are supplied with chisel tip needles as standard. Optional needles are available as listed below:

Flat Tip	2,3 or 4mm Dia.
Chisel Tip	3 or 4mm Dia.
Flat Tip Beryllium Copper	3mm Dia.



A selection of Chisel Scalers can be fitted with standard or Spark Resistant Chisels.

FEATURES AND BENEFITS:

Various Sizes and Handle Configurations

- Choose the best tool for the application

Adjustable/Adaptable Round or Straight Front Tubes

- Concentrates needle coverage for better results
- Less chance of needles bending

Versatile/Interchangeable Chisel Holders

- Accepts industry standard 1/2" (12mm) square shank chisels
- 3BPG model has a special chisel holder option 5/8" (16mm) hexagon shank chisels and scrapers up to 12" (300mm) wide

Minimum Parts, Maximum Performance

- All moving parts are steel (not plastic), for longer tool life and low maintenance

Flexible Chisel Positioning

- Provides operator comfort resulting in less fatigue

Low Vibration

- Low vibration tools reduce the risk of vibration related injuries

NEEDLE

SCALERS



Needle/Chisel Scaler kits available, includes a selection of spare needles & chisels to cover a range of applications

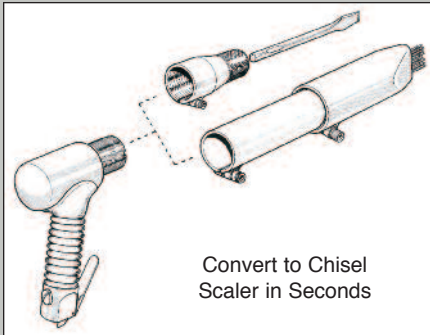

Convert to Chisel Scaler in Seconds

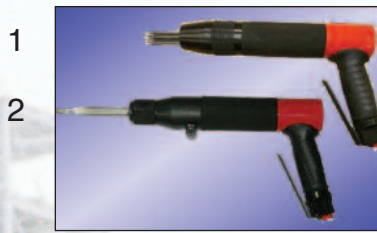

Model VL202
Pistol Grip

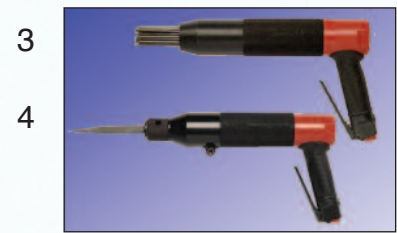

Model VL303 Challenger
Pistol Grip

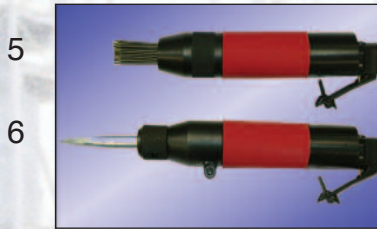

Model 1B
In-Line

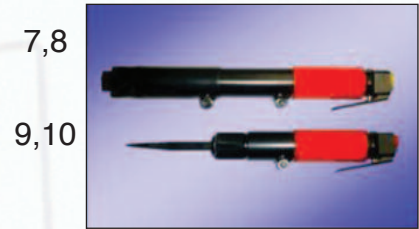

Model 2B
In-Line



Model 2BPG
Pistol Grip



Model 3B
Off Set Grip

Item No.	Model	Part No.	Needle Qty	Weight	Length	B.P.M.	Air Consumption
1	VL203 "Challenger" Needle Scaler *	196.2039	19 x 3mm	7.7lbs(3.5kg)	16.7"(425mm)	2200	5.5cfm (156lpm)
2	VL203 "Challenger" Chisel Scaler *	196.2339	N/A	7.9lbs(3.6kg)	15.7"(400mm)	2200	5.5cfm (156lpm)
3	VL303 "Challenger" Needle Scaler *	196.3099	28 x 3mm	7.7lbs(3.5kg)	14.5"(370mm)	3000	5.5cfm (156lpm)
4	VL303 "Challenger" Chisel Scaler *	196.3399	N/A	7.7lbs(3.5kg)	14.5"(370mm)	3000	5.5cfm (156lpm)
5	VL223 "Inline" Needle Scaler *	196.2139	19 x 3mm	7.7lbs(3.5kg)	16.7"(425mm)	2200	5.5cfm (156lpm)
6	VL223 "Inline" Chisel Scaler *	196.2239	N/A	7.9lbs(3.6kg)	15.7"(400mm)	2200	5.5cfm (156lpm)
7	1B Needle Scaler	111.1099	12 x 3mm	3.6lbs(1.7kg)	13.5"(343mm)	3800	3cfm (84lpm)
8	1B Chisel Scaler	114.1299	N/A	3.5lbs(1.6kg)	12.3"(313mm)	3800	3cfm (84lpm)
9	2B Needle Scaler	121.2099	19 x 3mm	5.8lbs(2.6kg)	14.8"(375mm)	3000	5.5cfm (156lpm)
10	2B Chisel Scaler	124.2299	N/A	4.4lbs(2.0kg)	13.5"(343mm)	3000	5.5cfm (156lpm)
11	2BPG Needle Scaler	123.2199	19 x 3mm	5.7lbs(2.6kg)	12.4"(315mm)	3000	5.5cfm (156lpm)
12	2BPG Chisel Scaler	125.2399	N/A	4.6lbs(2.1kg)	10.2"(260mm)	3000	5.5cfm (156lpm)
13	3B Needle Scaler	131.3099	28 x 3mm	9.9lbs(4.5kg)	18.3"(465mm)	2200	8cfm (226lpm)
14	3B Chisel Scaler	134.3299	N/A	7.5lbs(3.4kg)	16.8"(426mm)	2200	8cfm (156lpm)
15	3BPG Needle Scaler	133.3199	28 x 3mm	8.3lbs(3.8kg)	13.5"(342mm)	2200	5.5cfm (156lpm)
16	3BPG Chisel Scaler	135.3399	N/A	5.8lbs(2.6kg)	13.3"(339mm)	2200	5.5cfm (156lpm)
17	4B Needle Scaler	141.4099	35 X 4mm	13.0lbs(5.9kg)	19.0"(482mm)	2200	8.5cfm (240lpm)
18	4B Chisel Scaler	144.4299	N/A	8.8lbs(4.0kg)	17.3"(440mm)	2200	8.5cfm (240lpm)

*Indicates Vibration Reduced Scalers

LONG REACH

SCALERS

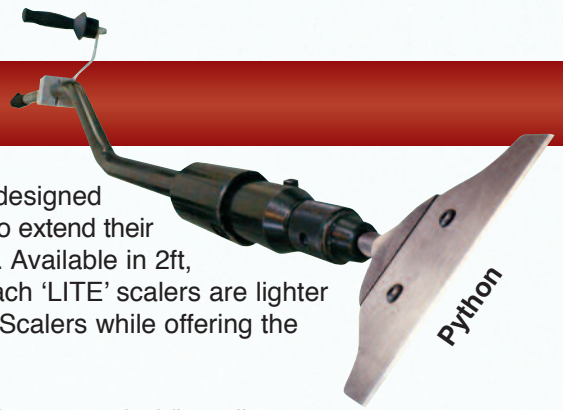
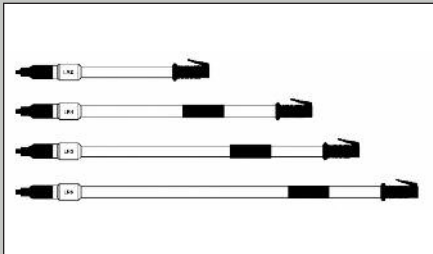
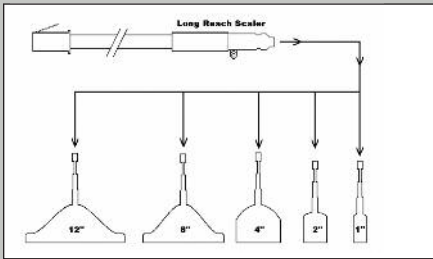

Long Reach Scalers are specifically designed to reduce the risk of back injury and to extend their use into previously inaccessible areas. Available in 2ft, 4ft, 5ft and 6ft lengths. The Long Reach 'LITE' scalers are lighter in weight than standard Long Reach Scalers while offering the same power.

A vast range of applications include the removal of floor tiles, residue, chemical spillages, ice, roofing materials, metal slag and tank cleaning. These tools are ideal for a variety of uses from construction and marine to general factory maintenance and flooring services. To help save on backaches, utilize our ergonomically designed Python Long Reach.

Available accessories include needle scaling attachments, scraper blades and a full range of standard 5/8\" hexagon shank chisels including spark resistant beryllium copper chisels for use in hazardous areas.

FEATURES AND BENEFITS:

Exclusively Designed Chisel Holder

- Modern single ball retainer for safe lock and quick fit
- Choose from the widest range of chisel and scraper blade widths available anywhere: 1\" (25mm) to 12\" (300mm) including 2\" (50mm) and 4\" (100mm) spark resistant sizes (see pages 8 & 9 for chisel / scraper details)



The True Convertibles

- Converts to needle scaler in seconds

Air Efficient & Economical To Use

- Consumes only 5 CFM @ 90 PSI. (2.1lps)
- Can be powered by a 2 HP compressor

Ruggedly Built

- Low maintenance, long service life
- Continued performance, even in harsh environments



Model	Part No.	Weight	Length	B.P.M.	Air Consumption
2ft Needle Scaler	137.3299	11.6lbs(5.3kg)	33.9\"(860mm)	2200	5cfm(126 lpm)
2ft Chisel Scaler	136.3299	10.2lbs(4.6kg)	29.2\"(740mm)	2200	5cfm(126 lpm)
4ft Needle Scaler	137.3499	12.8lbs(5.8kg)	48.0\"(1220mm)	2200	5cfm(126 lpm)
4ft Chisel Scaler	136.3499	11.5lbs(6.2kg)	43.3\"(1100mm)	2200	5cfm(126 lpm)
4ft LITE Needle Scaler	137.3497	8lbs(3.6kg)	48.0\"(1220mm)	2200	5cfm(126 lpm)
4ft LITE Chisel Scaler	136.3497	6.6lbs(3.0kg)	43.3\"(1100mm)	2200	5cfm(126 lpm)
5ft Needle Scaler	137.3599	15lbs(6.8kg)	59.8\"(1520mm)	2200	5cfm(126 lpm)
5ft Chisel Scaler	136.3599	12.9lbs(5.9kg)	55.1\"(1400mm)	2200	5cfm(126 lpm)
5ft LITE Needle Scaler	137.3597	9lbs(4.1kg)	59.8\"(1520mm)	2200	5cfm(126 lpm)
5ft LITE Chisel Scaler	136.3597	7.5lbs(3.4kg)	55.1\"(1400mm)	2200	5cfm(126 lpm)
6ft Needle Scaler	137.3699	14.8lbs(6.7kg)	72.0\"(1830mm)	2200	5cfm(126 lpm)
6ft Chisel Scaler	136.3699	13.9lbs(6.3kg)	67.3\"(1710mm)	2200	5cfm(126 lpm)
6ft LITE Needle Scaler	137.3697	9.5lbs(4.3kg)	72.0\"(1830mm)	2200	5cfm(126 lpm)
6ft LITE Chisel Scaler	136.3697	8.4lbs(3.8kg)	67.3\"(1710mm)	2200	5cfm(126 lpm)
PYTHON	156.6599	16.8lbs(7.6kg)	66.1\"(1680mm)	2200	5cfm(126 lpm)

BREAKER

HEAVY DUTY LONG REACH



The 'BREAKER' is a heavy duty long reach with a vibration isolated handle for operator comfort.

Applications include concrete reduction, removal of tough ceramic tiles, removal of thin set mortars and crack chasing. The 'BREAKER' can be fitted with rugged 1", 2", 3", or 4" wide hexagon shank chisels.

FEATURES AND BENEFITS:

- Modern single ball retainer for safe chisel locking and quick change
- Choice of rugged 1", 2", 3" or 4" wide chisels with industry standard 7/8" hexagon shank (see page 9 for chisel details)
- Vibration isolated handle for operator comfort
- Reduces damage to concrete substrates

Model	Part No.	Weight	Length	B.P.M.	Air Consumption
BREAKER	157.5599	27lbs(12.3kg)	58.3"(1480mm)	2000	20cfm(564 lpm)

LRS55

POLE SCABBLER & COMPACTOR



Ahead in their class, Long Reach Scabblers and Compactors can be supplied with interchangeable scabbling heads and tamper feet to suit most applications.

They are the most powerful tools for deep concrete dressing and for filler tamping especially in and around deep foundations and utility poles (when fitted with 4" or 6" tamper foot)

Model	Part No.	B.P.M.	Air Consumption	Weight
LRS55 c/w 5 point scabbler head	150.5099	1100	25cfm	30lbs(13.4kg)
LRS55 c/w 4"x4" compactor foot	150.5091	1100	25cfm	29lbs(13kg)
LRS55 c/w 6"x5" compactor foot	150.5092	1100	25cfm	30lbs(13.4kg)

FEATURES AND BENEFITS:

9" Throttle Handle

- Greater control & reduces fatigue

Angled Air Inlet

- For operator safety
- Situated below the throttle for better maneuverability

Large Piston Diameter

- Greater productivity





Selection of Heads Available

- Interchangeable scabbler and tamper heads for greater versatility

CHISELS & NEEDLES

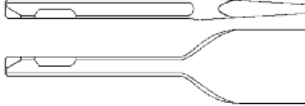
1/2" (12mm) SQUARE SHANK

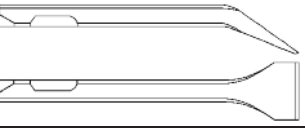
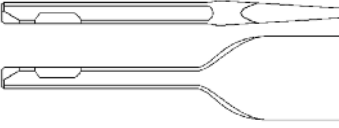
Chisels for Scaler models – 1B, 2B, 2BPG, 3B, 3BPG, 4B

	Part No.	Shank Type	Blade Width	Chisel Length	Special Applications
	704.1101	Square	3/4" (19mm)	7" (178mm)	Weld spatter removal
	704.1103	Square	2" (50mm)	7" (178mm)	Wide flat chisel for the removal of peeling paint and rust
	704.1107	Square	3" (75mm)	7" (178mm)	Wide flat chisel for the removal of peeling paint and rust
	704.2105	Square Cranked	1 3/8" (35mm)	7" (178mm)	Scraping thick coatings
	704.1110	Square	2" (50mm)	7" (178mm)	Spark resistant Aluminum Bronze for use in hazardous areas
	704.1106	Square	1/2" Diamond Point	7" (178mm)	Mortar rake for re-pointing brickwork

5/8" (16mm) HEXAGON SHANK

Chisels to suit the range of Long Reach Scalers including the Python and 3BPG model Chisel Scaler (when fitted with 5/8" Chisel Holder)

	Part No.	Shank Type	Blade Width	Chisel Length	Special Applications
	705.1101	Hex Straight	1" (25mm)	8" (203mm)	Flat chisel for sand cast chipping
	705.1106	Hex Straight	2" (50mm)	8" (203mm)	Removal of Tile/ Linoleum from floors
	705.1102	Hex Straight	4" (100mm)	8" (203mm)	Removal of Tile/ Linoleum from floors
	705.1100	Hex Straight	2" (50mm)	8" (203mm)	Spark Resistant Aluminum Bronze for use in hazardous areas
	705.1112	Hex Straight	4" (100mm)	8" (203mm)	Spark Resistant Aluminum Bronze for use in hazardous areas
	641.3512	Hex Straight	4" (100mm)	8" (203mm)	Blade holder for scraper-also known as the YOKE with hardware

CHISELS & SCRAPERS

5/8" (16mm) HEXAGON SHANK

Scrapers to suit the range of Long Reach Scalers including the Python and 3BPG model Chisel Scaler
(when fitted with 5/8" Chisel Holder)

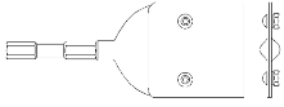
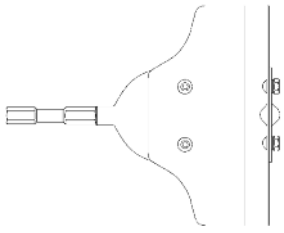
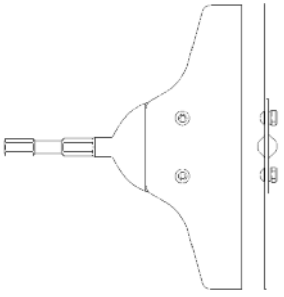
	Part No.	Shank Type	Blade Width	Chisel Length	Special Applications
	431.3904	Hex Straight	4" (102mm) Bevelled	10" (254mm)	Stubborn adhesive removal
	431.3928	Hex Straight	8" (203mm) Bevelled	10" (254mm)	Paint and coating spillage removal
	431.3922	Hex Straight	12" (305mm) Bevelled	10" (254mm)	Carpet and tile removal

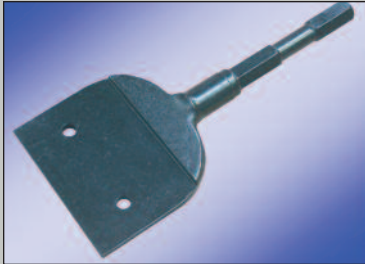

Blade Holder (Yoke)



Scraper Complete

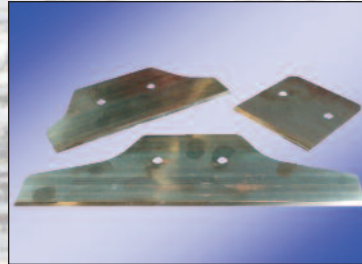

Replacement Scraper
Blades

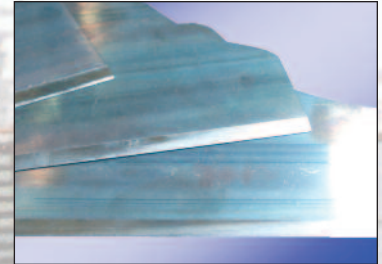

Bevel Edge

7/8" (22mm) HEXAGON SHANK

Chisels for the Long Reach Breaker

	Part No.	Shank Type	Blade Width	Chisel Length	Special Applications
	706.1101	Hex Straight	1" (25mm)	14" (360mm)	Removal of Terrazzo, Stubborn Ceramic, Marble Tiles and Thin-set
	706.1102	Hex Straight	2" (50mm)	14" (360mm)	Removal of Terrazzo, Stubborn Ceramic, Marble Tiles and Thin-set
	706.1103	Hex Straight	3" (75mm)	14" (360mm)	Removal of Terrazzo, Stubborn Ceramic, Marble Tiles and Thin-set
	706.1104	Hex Straight	4" (100mm)	14" (360mm)	Removal of Terrazzo, Stubborn Ceramic, Marble Tiles and Thin-set

SCALING/SCABBLING

HAMMERS



Single and Triple Head Scaling Hammers, in several distinct versions, are ideal tools to complement our needle scalers in more demanding applications for surface preparation and coatings removal.

Heavy Duty Scaling Hammers have proven to be the choice for “fracturing” thicker, tough to remove materials on concrete or steel. Scaling Hammers are fitted with Tungsten Carbide tipped cruciform heads but can be fitted with Tungsten Carbide tipped bush hammer heads as an option.

The Triple Head Scaling Hammer can be converted to an in-line configuration for hard to reach areas by simply exchanging the side handle for the main handle. Heavy duty Scaling Hammers use Tungsten Carbide single piece piston-head combinations for the preparation of steel or concrete surfaces

CUTTER HEADS FOR USE IN SINGLE AND TRIPLE HEAD HAMMERS



426.5351

Tungsten Carbide Tipped Cruciform Head – Detachable tapered (Standard) fit heads. For use in Scaling Hammers on steel surfaces for the removal of thick coatings, heavy rust and scale.



606.5303

Beryllium Copper Head – Detachable tapered fit head. For use in standard duty Scaling Hammers on steel surfaces for the removal of thick coatings, heavy rust and scale. Can be used safely in combustible areas.



612.5320

Tungsten Carbide Tipped Cruciform Head – Heavy Duty one piece piston-head combination. For use on steel and concrete surfaces for removing thick coatings, heavy rust and scale, or texturing/profiling surfaces.



612.5325

Tungsten Carbide Tipped Bush Hammer Head – Heavy Duty one piece piston and head combined. For use on concrete for bushing, laitance removal and for exposing concrete aggregate.

FEATURES AND BENEFITS:

Replaceable Scaling Heads

- Quickly change heads in the field or the workshop
- Less downtime, lower maintenance costs
- Tungsten Carbide cruciform and bush hammer heads stay sharper longer

Nylon Brush Seals

- Cleans pistons on each and every stroke
- Improve performance and extends tool life

Single Screw Cap Design

- Simplifies piston replacement

Air Inlet/Side Handle Port

- Converts to in-line configuration for even more versatility
- Side handle mounts easily for comfortable grip and stability

SCALING/SCABBLING

HAMMERS - Continued



Single Scaler including replaceable Tungsten Carbide tipped taper fit head
Part No. 151.5199-Long Handle
Part No. 199.5150-Short Handle



Triple Scaler including replaceable Tungsten Carbide tipped taper fit heads
Part No. 153.5399-Long Handle
Part No. 199.5350-Short Handle



HD-Single Scaler including single piece Tungsten Carbide head
Part No. 199.6192-Long Handle
Part No. 199.6190-Short Handle



HD-Triple Scaler including single piece Tungsten Carbide heads
Part No. 199.6392-Long Handle
Part No. 199.6390-Short Handle

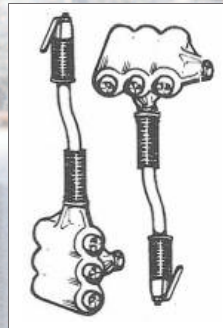

Triple Scaler/Scabblers in-line and standard configuration

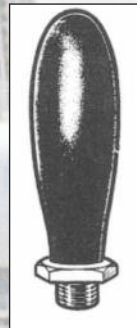

Side handle supplied with all Triple Scalers/Scabblers



Heavy Duty Single Piece Piston-Heads



Model	Part No.	Weight	Length	B.P.M.	Air Consumption
Standard Duty - Single Scaler including replaceable cruciform head	151.5199 199.5150	6lbs(2.7kg) 4lbs(1.8kg)	18"(457mm) 9"(229mm)	3800	5cfm(144 lpm)
Standard Duty - Triple Scaler including replaceable cruciform head	153.5399 199.5350	8lbs(3.6kg) 7lbs(3.2kg)	18"(457mm) 9"(229mm)	3 x 3000	11cfm(312 lpm)
Heavy Duty-Single Scaler including single piece cruciform head	199.6192 199.6190	9lbs(4.1kg) 8lbs(3.6kg)	18"(457mm) 9"(229mm)	2500	6.5cfm(186 lpm)
Heavy Duty-Triple Scaler including single piece cruciform head	199.6392 199.6390	13lbs(2.5kg) 12lbs(5.4kg)	18"(457mm) 9"(229mm)	3 x 2300	14cfm(408 lpm)

SHROUDED SF11

MULTI-HEADED STEEL DECK SCALER

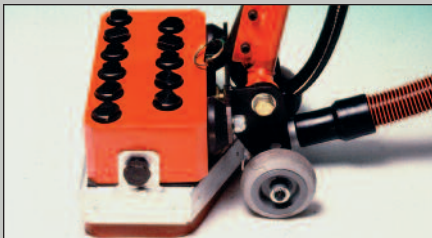
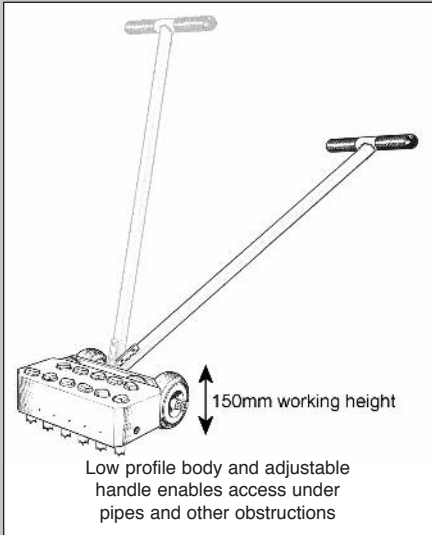

The Scaleforce Eleven is designed to provide rapid removal of scale or coatings from large areas of steel decks, tank floors and any other steel substrates. This tool compliments the hand-held Shrouded & Non Shrouded Scaling Hammers. The eleven heads impacting at 3000 blows per minute break down the hardest of scale / coatings, while the optional steel vacuum shroud captures contaminated dust and debris. All these features, along with a light weight design, makes this tool a must on all steel surfaces.

Specialized Application – Designed to provide rapid scale or coatings removal from steel substrates.

FEATURES AND BENEFITS:

Compact Body Design

- Less than 12"(300mm) across for working between structures or up to 5/8"(15mm) from edges

Solid Rubber Wheels

- Permanently mounted for easy transport into confined areas

Lightweight

- At only 79lbs. (36kgs), it is easier to maneuver than competitive units

Special Duplex Rubber Mounting System

- Protects the operator from high vibration levels
- Less fatigue

Multi-position Handle

- Allows easy access under obstructions

Simple Operation/Transport Design

- Lock and unlock handle in a flash

Powerful Piston Action

- 3000 blows per minute per piston

Durable Steel Vacuum Shroud

- Shroud captures contaminated dust and debris



Now available with a single piece piston incorporating the cutter-head.
Tungsten Carbide Cruciform or Bush Hammers Available

Model	Part No.	Weight	Length	Height	Width	Cutting Width	B.P.M.	Air Consumption
Scaleforce Eleven	159.5920	79.4lbs(36kg)	11.4"(290mm)	47.6"(1210mm)	11.1"(282mm)	9.92"(252mm)	11 x 3000	50cfm(1560 lpm)
Shrouded Scaleforce Eleven	159.5921	82lbs(37kg)	11.4"(290mm)	47.6"(1210mm)	11.1"(282mm)	9.92"(252mm)	11 x 3000	50cfm(1560 lpm)

SHROUDED MHS11

MULTI-HEADED CONCRETE SCABBLER



The MHS11 & Shrouded MHS11 Floor Scabbler was designed in association with construction engineers for thick coatings removal, containing and surface preparation of concrete. The MHS11 minimizes damage to the substrate. This prevents the ingress of water which can freeze and cause cracking. The MHS11 is even capable of concrete removal of up to 1/4" in one pass, making it ideal for removing radioactive or PCB contaminated concrete. Optional cruciform heads are available for material reduction with a smoother finish.

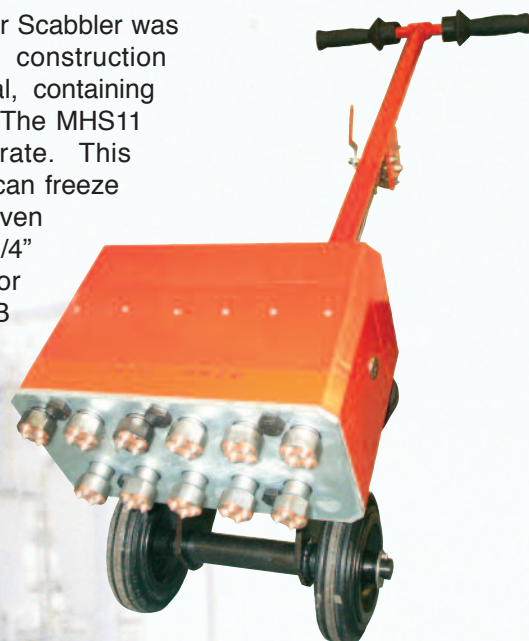

FEATURES AND BENEFITS:

Tungsten Carbide Tipped Heads

- 11 heads giving 2200 blows per minute per piston
- Designed to reduce damage to aggregate

Unique Cutter-head Action

- Piston exhausts into chamber which reduces wear to moving parts
- Prolongs tool life

3 Point Vibration Damping System

- Reduces operator fatigue
- Gives better control

Low Air Consumption

- Only requires 70cfm
- Economic running costs
- Operates from a single tool compressor

Compact Design

- Body width of only 11" (280mm) for work between structures

Works Within 1/2" of Walls

- Reduces the need for further finishing, tools and operations

Large Rear Wheels

- Aid maneuverability



Model	Part No.	Weight	Length	Height	Width	Cutting Width	B.P.M.	Air Consumption
MHS11	159.6000	154lbs(70kg)	13.4"(340mm)	50.8"(1290mm)	11.2"(285mm)	9.84"(250mm)	11 x 2200	70cfm(1982 lpm)
Shrouded-MHS11	159.6001	160lbs(70kg)	13.4"(340mm)	50.8"(1290mm)	11.2"(285mm)	9.84"(250mm)	11 x 2200	70cfm(1982 lpm)

TFP200

FLOOR SCARIFIER/PLANERS



TFP200

The TFP200 presents a combination of innovative technology with performance tested features and benefits in a rugged rotary planer unit. The modern integral design of the TFP provides an easier to maneuver unit and ensures even profiling and a higher work rate.

Suitable for rapidly removing scale, rust, paint and other deposits from steel surfaces in preparation for re-coating.

FEATURES AND BENEFITS:

Accurate Depth Control

- Improves overall performance
- Extends cutter assembly life

Stable Four Wheel Transport System

- Large diameter rear wheels for better mobility
- Additional two front wheels for stability

Fully Adjustable Handlebar

- Provides greater operator comfort
- Adjust for each individual worker

Built in Safety Features

- Hold-to-run handle ensures the machine will not run unattended

Choice of Power Source

- Air, electric and gas models available

Vacuum Adaptor Fitted as Standard

- For removal of nuisance dust when attached to a **Novatek** vacuum system

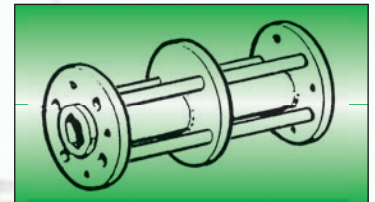

Heavy Duty Drum
Fitted as Standard
Part No. 320.002H

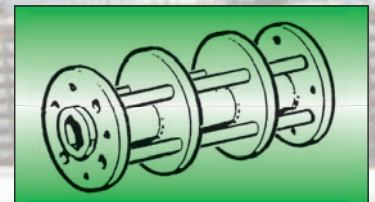

Grooving Drum
Fitted upon Request
Part No. 320.000G

TFP-200 Models	Part No.	1ph 50Hz	3ph 50Hz	1ph 60Hz	3ph 60Hz
Gas	320.2000				
110v Electric		320.2002		320.2003	
220-240v Electric				320.2005	320.2022
380-440v Electric			320.2006		320.2007
Air	320.2012				

TFP200

FLOOR SCARIFIER/PLANERS - Continued

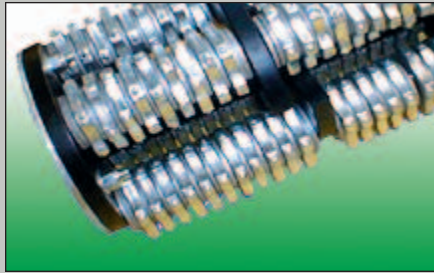

Tungsten Carbide Tipped Cutter

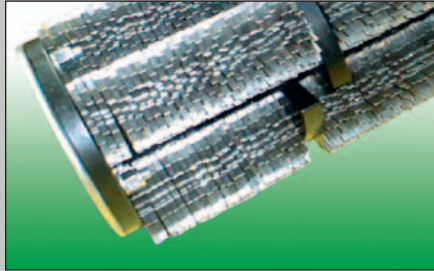

Star Cutter

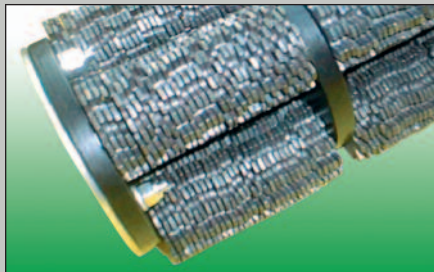

Beam Cutter



Milling Cutter

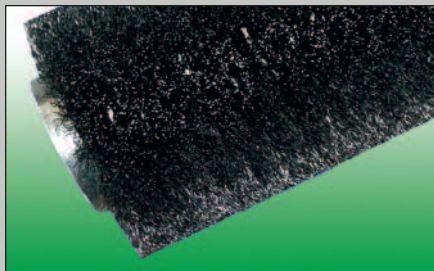

Wire Brush Assembly



STANDARD CUTTER TYPES

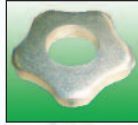

Tungsten Carbide Tipped Cutter – Hardened steel with Tungsten Carbide inserts for all concrete texturing, scabbling, planing and grooving applications. Also used for the removal of road markings, roof chippings and brittle coatings.



Star Cutters – Heat treated steel cutters for the removal of paint coatings and laitance from new floors. More aggressive than the beam cutter. Also used for removing build up of grease, dirt and ice.



Beam Cutter – Heat treated steel cutter for the removal of paint, coatings and laitance from new floors. Also for removing build up of grease, dirt and ice.



Milling Cutter – Tungsten Carbide tipped cutter for the removal of thermoplastic road and runway markings, bituminous and rubber deposits.



Wire Brush – Twisted knot or crimped wire, for general workshop cleaning and removal of light surface rust. (Only available for the TFP200)

Model	Heavy Duty Drum	
	Cutters	Washers
TFP200 with TCT Cutters	76	88
TFP200 with Star Cutters	220	0
TFP200 with Beam Cutters	220	0
TFP200 with Milling Cutters	24	76

Model	Working Width	Weight	Length	Width	Height	Cutter Speed	Air Consumption	Power	Voltage
TFP200 Gas	8"(200mm)	130 lbs (59kg)	31.5"(800mm)	13.8"(350mm)	39"(1000mm)	1833	N/A	5.5HP	N/A
TFP200 Electric	8"(200mm)	150 lbs (68kg)	31.5"(800mm)	13.8"(350mm)	39"(1000mm)	1650	N/A	2.2HP	110-440v
TFP200 Air	8"(200mm)	150 lbs (68kg)	31.5"(800mm)	13.8"(350mm)	39"(1000mm)	1650	115cfm(3256 lpm)	5.0HP	N/A

NEEDLE SCALERS

VACUUM SHROUDED



Pneumatic Shrouded Needle Scalers provide a thorough and effective means of removing coatings, corrosion and other accumulated materials. Combine this with our legendary hitting power and you have a state of the art piece of equipment capable of rapid coatings removal with no harmful dust emissions. These scalers will work on almost any surface including irregular surfaces that are otherwise hard to prepare. Some examples of cleaning capabilities are: Rivet heads, Corners, Edges, Weld seams, Steel door jams, Steel window sills, Bridge bearings, Tubing, Concrete, etc.

Please consult Novatek for further details on range of low vibration Needle/Chisel Scalers.

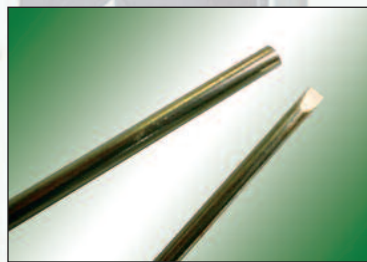

All Needle Scalers are supplied with chisel tip needles as standard. Optional needles are available as listed below:

Flat Tip	2,3 or 4mm Dia.
Chisel Tip	3 or 4mm Dia.
Flat Tip Beryllium Copper	3mm Dia.

FEATURES AND BENEFITS:

Various Sizes and Handle Configurations

- Choose the best vacuum shrouded tool for your application

Adjustable/Adaptable Vacuum Front Tubes

- Concentrates needle coverage for better results
- Less chance of needles bending

Heavy Duty Components

- Hardened steel parts for greater wear resistance
- All moving parts are steel (not plastic) for longer tool life and low maintenance

Flexible Wear Cuffs

- Provides proper surface coverage even in hard to reach areas
- Interchangeable Cuffs for irregular surfaces
- Wear Cuffs insure efficient capture and containment of hazardous materials

Vacuum Recovery / Exhaust

- Bottom tool exhaust prevents exhausted air working against vacuum recovery
- Various Needle Gun configurations allow for vacuum recovery from difficult to reach areas with no interference from vacuum hoses or air lines

Low Vibration

- Shrouded low vibration tools help reduce risk of vibration related injuries

NEEDLE SCALERS

VACUUM SHROUDED



Corner Wear Cuff



Edge Wear Cuff



SHROUDED PISTOL GRIP SCALER
2B/PG – 139.2107
3B/PG – 139.3107



SHROUDED PISTOL GRIP SCALER KIT
2B/PG – 139.2100
3B/PG – 139.3100



SHROUDED VL303 "LOW VIBRATION"
SCALER KIT
139.3099



SPECIFICATIONS: All needle scalers are equipped with 1/4" NPT air inlet.

Model	Part No.	Needle Qty	Weight	Length	B.P.M.	Air Consumption	Cylinder Bore	Piston Stroke
2B Inline Needle Scaler	139.2007	19 x 3mm	5.7lbs(2.6kg)	18.5"(470mm)	3000	5.5CFM (156 lpm)	.925"	1.40"
2B Inline Needle Scaler Kit	139.2000	N/A	16lbs(7.2kg)	N/A	3000	5.5CFM (156 lpm)	.925"	1.40"
2B/PG Shrouded Needle Scaler	139.2107	19 x 3mm	5.7lbs(2.6kg)	12.4"(315mm)	3000	5.5CFM (156 lpm)	.925"	1.40"
2B/PG Shrouded Needle Scaler Kit	139.2100	N/A	16lbs(7.2kg)	N/A	3000	5.5CFM (156 lpm)	.925"	1.40"
3B/PG Shrouded Needle Scaler	139.3107	28 x 3mm	8.8lbs(4.0kg)	13.5"(342mm)	2200	8CFM (228 lpm)	1.125"	1.54"
3B/PG hrouded Needle Scaler Kit	139.3100	N/A	19lbs(8.6kg)	N/A	2200	8CFM (228 lpm)	1.125"	1.54"

Model	Part No.	Needle Qty	Weight	Length	B.P.M.	Air Consumption	Cylinder Bore	Piston Stroke
Shrouded VL303 Needle Scaler Kit	139.3099	N/A	16lbs(2.6kg)	N/A	3000	5.5CFM (156 lpm)	1.125"	1.54"



These versatile, high production tools are ideal for the removal of coatings from both steel and concrete substrates. Quick change hubs with an assortment of abrasives enables you to rapidly remove everything from mastics and alkyds to epoxy coatings while containing hazardous dust. The PPT, with star or beam cutters, will remove coatings from many types of piping and curved surfaces. If you need a tool that will do everything from profiling steel to removing hazardous coatings, the PPT is the tool that gets the job done.

VSE Peening Preparation Tools utilize 3M™ brand Heavy Duty Tungsten Carbide tipped Rotopeen™ flaps. In accordance with SSPC surface preparation specifications it may be necessary to utilize more than one type of cleaning device to achieve SP-11.

Contact Novatek for further information and advice on the complete Tool & Vacuum System range.

FEATURES AND BENEFITS:

Lightweight Tools

- Can be used vertically and overhead

Available with a Variety Cutting Media

- Imitates a shot blast finish
- Converts in one minute to accept other surface preparation media

Optimized Power Source Maintains Speed Under Load

- Maximizes coatings removal

Optional Accessories

- Star cutters for tackling more demanding applications such as non-skid, PRC and coal tar removal
- Available with compressed air or electric drive motors, 2" or 4" cutting widths

US Patented Vacuum Shroud

- Engineered specifically for lead based paint removal
- Maximizes debris capture and virtually eliminates detectable dust emissions
- Complies with OSHA and EPA standards easily when matched with VSE HEPA vacuums
- Vacuum ports as standard for dust free working

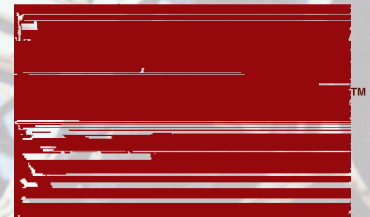

PEENING PREP TOOLS - continued



C Flap
For steel and concrete applications



Star Cutter
Aggressive removal of thick coatings including non-slip



Beam Cutter
Removal of hard coatings including epoxy



2" (50mm) Air version



2" (50mm) Electric version

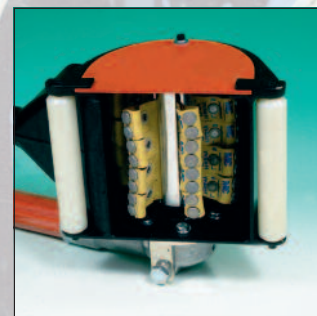

4" (100mm) Air version

Peening Prep Tool Kits Include:
Tool fitted with 3M HD Rotopeen™
One (1) complete Rotopeen™ hub fitted w/Flaps
One (1) complete hub with star cutters
All packaged in a rugged carrying case

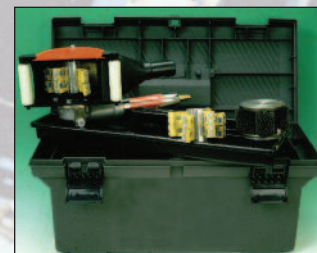

2" PPT KIT - 139.0205

Model	Part No.	Working Width	Weight	Length	Width	Height	R.P.M.	Air Consumption	Air Pressure Reg.	VOLTAGE	Power
2" Air With Flaps	194.0205	2.4" (60mm)	7.5lbs (3.4kg)	14" (356mm)	6.25" (159mm)	6" (152mm)	2700	30cfm (840 lpm)	90 PSI	N/A	1.2HP
2" Air With Cutters	194.C205	1.97" (50mm)	11.5lbs (5.2kg)	14" (356mm)	6.25" (159mm)	6" (152mm)	2700	30cfm (840 lpm)	90 PSI	N/A	1.2HP
2" Air PPT Kit	139.0205	2.4" (60mm)	18lbs (8.2kg)	19" Tool Box	N/A	N/A	2700	30cfm (840 lpm)	90 PSI	N/A	1.2 HP
4" Air With Flaps	194.0405	4.3" (110mm)	9lbs (4.1kg)	14" (356mm)	7.8" (197mm)	6" (152mm)	3000	30cfm (840 lpm)	90 PSI	N/A	1.2HP
4" Air With Cutters	194.C405	3.9" (100mm)	14lbs (6.4kg)	14" (356mm)	7.8" (197mm)	6" (152mm)	3000	30cfm (840 lpm)	90 PSI	N/A	1.2HP
4" Air PPT Kit	139.0405	4.3" (110mm)	23lbs (10.4kg)	22" Tool Box	N/A	N/A	3000	30cfm (840 lpm)	90 PSI	N/A	1.2HP
2" Electric With Flaps	194.0215	2.4" (60mm)	10lbs (4.45kg)	20" (508mm)	6.25" (159mm)	6" (152mm)	2300	N/A	N/A	120	1200W 8AMP
2" Electric With Cutters	194.C215	1.97" (50mm)	14lbs (6.4kg)	20" (508mm)	6.25" (159mm)	6" (152mm)	2300	N/A	N/A	120	1200W 8AMP
2" Electric PPT Kit	139.0215	2.4" (80mm)	23lbs (10.4kg)	22" Tool Box	N/A	N/A	2300	N/A	N/A	120	1200W 8AMP
4" Electric With Flaps	194.0415	4.3" (100mm)	14lbs (6.4kg)	20" (508mm)	7.8" (197mm)	6" (152mm)	2300	N/A	N/A	120	1200W 8AMP
4" Electric With Cutters	194.C415	4.3" (110mm)	16lbs (6.4kg)	20" (508mm)	7.8" (197mm)	6" (152mm)	2300	N/A	N/A	120	1200W 8AMP
4" Electric PPT Kit	139.0415	4.3" (110mm)	26lbs (6.4kg)	20" (508mm)	7.8" (197mm)	6" (152mm)	2300	N/A	N/A	120	1200W 8AMP

GRINDERS

SHROUDED RIGHT ANGLE



5" Air Floating Head Grinder
Part No.195.5501

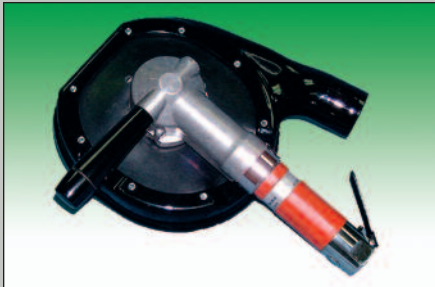

7" Air Floating Head Grinder
Part No.195.5701



5" Elec. Floating Head Grinder
Part No.195.5551



7" Elec. Floating Head Grinder
Part No.195.5751



The 5" & 7" Shrouded Right Angle Grinders are ready to tackle your toughest grinding surface preparation needs. Whether you're grinding coatings for spot cleaning or feathering for recoating, our grinders can handle the challenge with dust free ease.

Novatek's Shrouded Right Angle Grinders utilize a 3M™ brand Coating Removal Discs or CRD®. The advantage of this non-woven, open web disc is that it will remove residual coatings or impacted corrosion into the substrate after coatings removal with the Shrouded Needle Scales or PPT, but will not destroy the surface profile produced by these tools. In accordance with SSPC surface specifications, it may be necessary to utilize more than one type of cleaning device to achieve SP-11 power tool cleaning to bare metal.



FEATURES AND BENEFITS:

Heavy Duty Motor

- The 1.2HP Pneumatic and 120volt, 8.0Amp Electric Motors maintain speed under load to maximize coatings removal.

Power Source

- Single power source for PPT and Grinders standardizes all replacement bearings, vanes etc.

Note: PPT's rotational speed is 2300-3000 RPM

Grinders rotational speed is 5500 RPM

Floating Shrouds

A flexible shroud with a 360° radial vacuum take-off insures even air flow and maximum capture of dust & debris. The floating shrouds can even utilize a full range of abrasives to tackle your toughest grinding needs.

SPECIFICATIONS: All Air Grinders are equipped with 1/4" NPT air inlet.

Model	Part No.	Working Width	Weight	R.P.M.	Air Consump.	Air Press.	Voltage	Power
5" Air Shrouded Grinder	195.5501	5" (127mm)	7.5lbs (3.4kg)	5500	30cfm (840 lpm)	90 PSI	N/A	1.2HP
7" Air Shrouded Grinder	195.5701	7" (177mm)	11.5lbs (5.2kg)	5500	30cfm (840 lpm)	90 PSI	N/A	1.2HP
5" Electric Shrouded Grinder	195.5551	5" (127mm)	10lbs (6.4kg)	0-3000	N/A	N/A	120	1200W 8AMP
7" Electric Shrouded Grinder	195.5751	7" (177mm)	14lbs (6.4kg)	0-3000	N/A	N/A	120	1200W 8AMP

GRINDERS

SHROUDED MINI GRINDER

Problems grinding those tight, difficult to reach areas are now solved with Novatek's Shrouded Mini Grinder. The fixed head design allows grinding and coatings removal up to edges, corners and on irregular surfaces. The convertible design allows you to adapt 1.5" & 2" abrasive disks. The parallel vacuum takeoff permits grinding in tight areas only 2" wide. Novatek's Shrouded Mini Grinders utilize a 3M™ Roloc brand Coating Removal Discs (CRD®). The advantage of this non-woven, open web disc is that it will remove residual coatings or impacted corrosion into the substrate. Novatek also offers a vast assortment of abrasives for surface preparation on wood, aluminum and steel. Whether you're grinding coatings for spot cleaning or feathering for recoating, our grinders can handle the challenge with dust free ease.



FEATURES AND BENEFITS:

Convertible Design

- Accepts 1 1/2" and 2" abrasives all in one tool

Ergonomic Parallel Vacuum Takeoff

- Allows dustless grinding/sanding in difficult to access areas and eliminates awkward positioning grip, resulting in reduced worker fatigue

Rapid Removal

- Powerful drive motor maintains RPM's for removal of hazardous and non-hazardous material

Versatile

- Quick change disks allow for grinding, sanding or surface conditioning; wet or dry!

SPECIFICATIONS: All Air Grinders are equipped with 1/4" NPT air inlet.

Model	Part No.	Working Width	Weight	R.P.M.	Air Consump.	Air Press.	Power
Shrouded Mini Grinder	195.1100	1 1/2"-2" (38-50mm)	3lbs (1.2kg)	15,000	6cfm (156 lpm)	90 PSI	.5HP
Shrouded Mini Grinder Kit	195.1105	1 1/2"-2" (38-50mm)	5.8lbs (2.6kg)	15,000	6cfm (156 lpm)	90 PSI	.5HP



SCALING HAMMERS

SHROUDED



The Shrouded Single and Triple Head Scaling Hammers are ideal tools to compliment the Shrouded Needle Scalers in more demanding applications for surface preparation and coatings removal with vacuum containment .

These Shrouded Heavy Duty Scaling Hammers have proven to be the choice for “fracturing” thicker, tough to remove materials and concrete dressing. Scaling Hammers are fitted with Tungsten Carbide tipped cruciform heads but can be fitted with Tungsten Carbide tipped bush hammer heads as an option.

The Shrouded Triple Head Scaling Hammers can be converted to an in-line configuration for hard to reach areas by simply exchanging the side handle for the main handle.

Scaling Hammers use a Tungsten Carbide single piece piston-head combination for preparation of steel and concrete surfaces.

CUTTER HEADS FOR USE IN SINGLE AND TRIPLE HEAD SCALERS



612.5320

Tungsten Carbide Tipped Cruciform Head –Heavy Duty one piece piston-head combination. Used on steel and concrete surfaces for removing thick coatings, heavy rust and scale, or texturing/profiling surfaces.



612.5325

Tungsten Carbide Tipped Bush Hammer Head –Heavy Duty one piece piston-head combination. Used on concrete for bushing, laitance removal and for exposing concrete aggregate.

FEATURES AND BENEFITS:

Replaceable Single Piece Scaling Heads

- Quickly change heads in the field or the workshop
- Less downtime, lower maintenance costs
- Tungsten Carbide cruciform and bush hammer heads stay sharper longer

Nylon Brush Seals

- Cleans pistons on each and every stroke
- Improves performance and extends tool life

Single Screw Cap Design

- Simplifies piston replacement

Air Inlet/Side Handle Port

- Converts to in-line configuration for even more versatility
- Side handle mounts easily for comfortable grip and stability

Vacuum Shroud

- Durable steel shroud for maximum capture and containment of debris

SCALING HAMMERS

SHROUDED - Continued

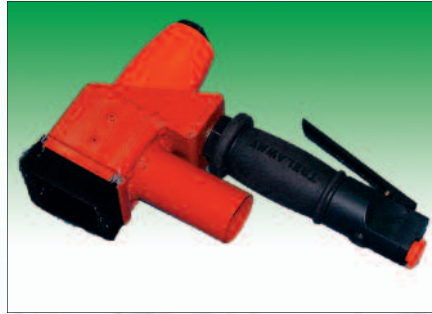

Shrouded Single Scaler including single piece Tungsten Carbide head
Part No. 139.6190-Short Handle



Shrouded Triple Scaler including single piece Tungsten Carbide heads
Part No. 139.6390-Short Handle



Shrouded Single Scaler including single piece Tungsten Carbide head
Part No. 139.6192-Long Handle



Shrouded Triple Scaler including single piece Tungsten Carbide heads
Part No. 139.6392-Long Handle

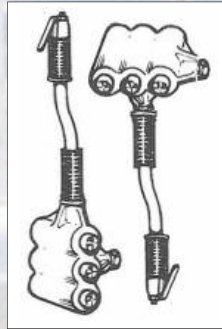

Triple Scaler/Scabblers in-line and standard configuration

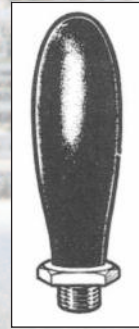

Side handle supplied with all Triple Scalers/Scabblers

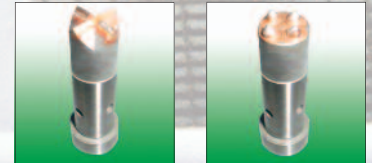

Heavy Duty Single Piece Piston Heads



Model	Part No.	Weight	Length	B.P.M.	Air Consump.	Cylinder Bore	Piston Stroke
Shrouded Heavy Duty-Single Scaler - Short Handle	139.6190	9lbs(4.1kg)	9"(229mm)	2500	6.5cfm(186 lpm)	1.06"	1.04"
Shrouded Heavy Duty-Single Scaler - Long Handle	139.6192	10lbs(4.6kg)	18"(457mm)	2500	6.5cfm(186 lpm)	1.06"	1.04"
Shrouded Heavy Duty-Triple Scaler - Short Handle	139.6390	13lbs(5.9kg)	9"(229mm)	3 x 2300	14cfm(408 lpm)	1.06"	1.04"
Shrouded Heavy Duty-Triple Scaler - Long Handle	139.6392	14lbs(6.4kg)	18"(457mm)	3 x 2300	14cfm(408 lpm)	1.06"	1.04"

SHROUDS

DDS-1 DUSTLESS DRILL SHROUD



Accommodates bits up to 1" in diameter



Easily attaches & fully adjustable to a variety of drills



Novatek is proud to introduce our new **DDS-1 Dustless Drill Shroud**. Our Drill Shroud easily attaches to most drills including Dewalt, Craftsman, Bosch, Makita and Ryobi. Retrofit your existing drill into a total dust free shrouded drill in a matter of minutes! Our Dustless Drill shroud is fully adjustable to ensure containment in the tightest areas. Made to fit drill bits up to 1", our Drill Shroud is the answer to all of your dustless drilling needs.

Retrofits to your existing drill in seconds!

Innovative Shroud Designs

- Adjustable shroud ensure accurate and consistent cutting depth

Accepts a Wide Variety of Bits

- Will accept drill bits up to 1" in diameter
- Fits a variety of bits including High Speed Steel, Wood, Concrete, and even Spade Bits!

Totally Dustless Applications

- When combined with any number of our high efficiency vacuums the DDS-1 Drill Shroud creates a dust free environment.

Model	Part No.	Bit Width	Drill Depth
DDS-1 Dustless Drill Shroud	499.3000	Up to 1"	Up to 4"

DDS-3 DUSTLESS DRILL SHROUD



Accommodates bits up to 2 7/8" in diameter!



Easily attaches & fully adjustable to a variety of drills



The world of "DustFree" drilling with the **Novatek DDS-3 Dustless Drilling System!** Our universal dust shroud easily adapts to variety of drills including Dewalt, Milwaukee, Bosch, Makita, and Ryobi just to name a few.

Our Dustless Drill shroud is fully adjustable to ensure containment in the tightest areas. Made to fit drill bits up to 2 7/8", our DDS-3 Drill Shroud is the answer to all of your dustless drilling needs.

Retrofits to your existing drill in seconds!

Innovative Shroud Design

- Adjustable heavy duty steel shroud ensures accurate and consistent drilling

Compatible with Wide Variety of Bits

- Accepts drill bits up to 2 7/8" in diameter

Totally Dustless Applications

- Creates a dust free environment when combined with any number of our high efficiency vacuums.

Model	Part No.	Bit Width	Drill Depth
DDS-3 Dustless Drill Shroud	499.3100	Up to 2 7/8"	Up to 2"

* Note: Adapts to fit Milwaukee Hole Hog Drill with purchase of separate collar. Part: 499.3200

SHROUDS & DUCTING

UNIVERSAL GRINDER SHROUDS

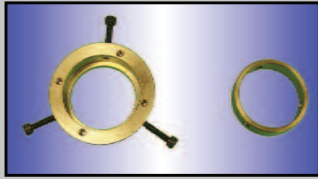

2" ID & 1.7" ID
Collar Set

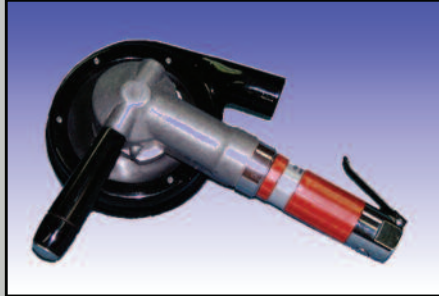

Novatek presents our renowned "Floating Head" Grinder Shroud

for Bosch, Makita, Dewalt, Metabo, and B&D Grinders!
In less than 5 minutes you can retrofit your existing grinder into a total dust free surface grinder. Our unique rubber diaphragm allows you to maneuver your grinder as if you have no shroud on it at all! The "Perma Seal" always stays in contact with the work surface, regardless of your angle of attack. Our Floating Head Shrouds are quite simply the easiest, most effective and comfortable form of dust control available for your grinders!

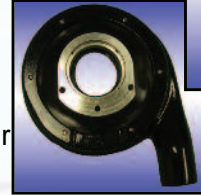
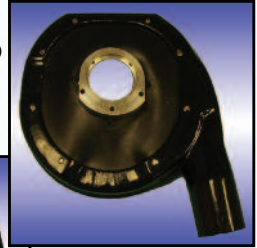

Model	Part No.	Ring Size ID	Tools to Fit
5" Enclosed Shroud	499.U005	1.7" or 2"	B&D, Makita, Bosch, Dewalt, Metabo
7" Bull Nose Shroud	499.U007	1.7" or 2"	B&D, Makita, Bosch, Dewalt, Milwaukee

DUCT-2-GO

Are you Frustrated by:

- Piles of damaged, twisted ducting?
- Wrestling with cheap, disposable ducting?
- Wasting money on disposable ducts or lay-flat?



Is the answer!

The Duct-2-Go system incorporates heavy duty PVC ducting into a portable, self contained carrying case that is actually part of the ducting! Eliminate clutter by having up to 50' of durable vinyl duct in a compact bag only 3' long! Designed to stand up to the harshest conditions, the Duct-2-Go is built to last!



Model	Part No.	Duct Diameter	Duct Length
DUCT-2-GO	D1025	10 inch	25 feet
DUCT-2-GO	D1050	10 inch	50 feet
DUCT-2-GO	D1225	12 inch	25 feet
DUCT-2-GO	D1250	12 inch	50 feet

DURAVENT

PORTABLE VENTILATION MACHINE



DuraVent is Portable & Light Weight

The Next Generation Portable Blower/Ventilator

Novatek, the premier choice of rotationally molded, polyethylene filtration equipment, proudly introduces the **DuraVent**.

This *virtually indestructible* blower/ventilator brings new power and durability to the portable ventilation market. The **DuraVent** is dent proof, leak proof, and converts from discharge to suction in seconds!

FEATURES AND BENEFITS:

- Powerful 1/3 Horse Power motor generates exceptional, consistent air flow.
- Thermally protected motor for maximum fan life and safety.
- High impact polyethylene housing for extreme durability.
- **25Ft. of ducting included** for fast intake or exhaust of air.
- Converts air flow from intake to exhaust in mere seconds.
- UL CSA DNV recognized motor.



DuraVent Blower



Model	Part No.	Weight	Dimensions	Motor	Air Flow w/ Ducting	Power Requirements	Noise Level
DuraVent w/ 25ft. Ducting & Carrier	V1000	40 LBS	34" X 12" X 14"	1/3HP, Thermally Protected	Free Air - 860CFM 1-90°- 612 CFM 2-90°- 560 CFM	110V/60Hz, 2.4 Amps	74 dB

NOVAIR 1000

NEGATIVE AIR MACHINE



**POWERFUL, DURABLE,
RELIABLE & LIGHT WEIGHT
CREATES
"THE ULTIMATE MACHINE"
THE NOVAIR F1000
*Virtually Indestructible!***

Features and Benefits:

- Powerful 3/4 Horse Power motor generates exceptional, consistent flow rate and utilizes all filter media area
- 2 Speed motor - provides consistent air flow of 1000cfm (high speed) & 500cfm (low speed)
- 8 point motor / cage mounting prevents motor and cage shifting even under the harshest conditions **"No more Rubbing Cages!"**
- Seamless construction guarantees leak proof operation
- Lightweight design with incorporated skids allow for easy and safe transport
- Positive lock filter prevents filter movement for uninterrupted filtration
- Uses standard 16" x 16" HEPA filters
- General Purpose Filters & Audible Alarms available
- Custom controls & features available upon request

- Integrated Skids and Handle make easy work of stairs
- Standard 10" Exhaust Port
- Large 8" Non-Marring Wheels
- 10" Intake Door Available



Front control panel

Includes minihelic pressure gauge, circuit breaker and is available with audible & visual alarm



Pad & Ring Filters



Replacement Hepa Filter

Model	Part No.	Weight	Dimensions	Motor	Air Capacity	Power Requirements	Filtration
NOVAIR 1000 w/ Hepa Filter	F1000	94 LBS	20" X 23" X 40"	3/4HP-Two Speed, Thermally Protected	High- 1000 CFM Low- 500 CFM	115 Volt, 5 Amp,60Hz	Hepa Filter,1/2" Pad Ring Filter
NOVAIR 1000 w/ Hepa, Audible & Visual Alarms	F1002	94 LBS	20" X 23" X 40"	3/4HP-Two Speed, Thermally Protected	High- 1000 CFM Low- 500 CFM	115 Volt, 5 Amp,60Hz	Hepa Filter,1/2" Pad Ring Filter
NOVAIR 1000 w/ General Purpose Filter	F1005	91 LBS	20" X 23" X 40"	3/4HP-Two Speed, Thermally Protected	High- 1000 CFM Low- 500 CFM	115 Volt, 5 Amp,60Hz	Dust Filter,1/2" Pad Ring Filter

NOVAIR 2000

NEGATIVE AIR MACHINE

“THE COMPLETE PACKAGE”

OUR MOST POWERFUL,

DURABLE & LIGHT WEIGHT

NEGATIVE AIR MACHINE AVAILABLE!

Virtually Indestructible!!

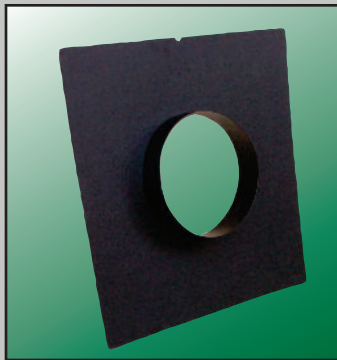

12" Vacuum Intake
Part # F2012

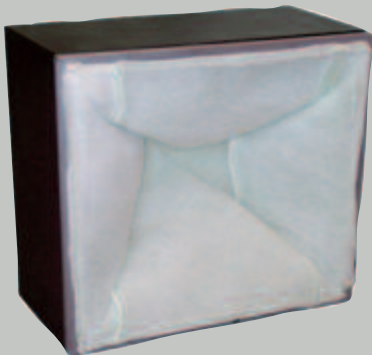

General Purpose Filter Kit
Part # F4000

FEATURES AND BENEFITS:

- Powerful 2 Horse Power motor generates exceptional, consistent flow rate and utilizes all filter media area.
 - 2 Speed motor - provides consistent air flow of 2000cfm (high speed) and 1000cfm (low speed)
 - 8 point motor / cage mounting prevents motor and cage shifting even under the harshest condition.
- “No more Rubbing Cages!”**
- Seamless construction guarantees leak proof operation.
 - One of the lightest 2000 CFM units on the market is easily transported by 2 operators.
 - Positive lock filter prevents filter movement for uninterrupted filtration.
 - Uses standard 24" x 24" HEPA filter, rated 99.97% efficiency against 0.3 micron particles.
 - General Purpose Filters & Audible Alarms available.
 - Custom controls & features available upon request.



Replacement Hepa Filter

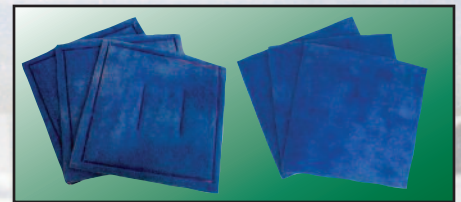

Pad & Ring Filters

Model	Part No.	Weight	Dimensions	Motor	Air Capacity	Power Requirements	Filtration
NOVAIR 2000 c/w Hepa Filter	F2100	135LBS	37" X 26" X 31"	2HP-Two Speed, Thermally Protected	High- 2000 CFM Low- 1200 CFM	115 Volt, 15 Amp,60Hz	Hepa Filter,1/2" Pad Ring Filter
NOVAIR 2000 c/w Hepa, Audible & Visual Alarms	F2102	135 LBS	37" X 26" X 31"	2HP-Two Speed, Thermally Protected	High- 2000 CFM Low- 1200 CFM	115 Volt, 15 Amp,60Hz	Hepa Filter,1/2" Pad Ring Filter
NOVAIR 2000 c/w General Purpose Filter	F2105	118 LBS	37" X 26" X 31"	2HP-Two Speed, Thermally Protected	High- 2000 CFM Low- 1200 CFM	115 Volt, 15 Amp,60Hz	Dust Filter,1/2" Pad Ring Filter

NOVASTRIP 1026

INFRARED HEAT TILE MACHINE

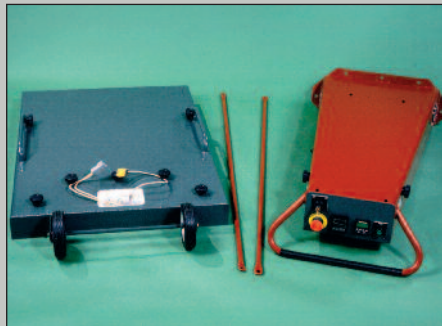

Modular Design



NOVASTRIP 1026



NEW Control Panel

Finally! A Safe, Efficient, and Cost Effective Way to Remove Vinyl Tile

The **Novastrip 1026** VAT stripper utilizes "Infrared radiant heat" to safely heat tiles, thus breaking the adhesive bond. This allows you to lift **Intact** tiles in a dustless environment. In the past, wetting and hand scraping was the most common method of removal. This process has proven to be labor intensive and generates a great deal of cleanup. Since water is not required with the Novastrip, the job is completed with an absolute minimum volume of waste. These machines also cut labor costs by requiring only one operator. Simply place the machine over your tiles to be removed, set the timer and allow it to complete its cycle. Move the machine to the next set of tiles, then easily remove the previously heated tiles.

It's That Simple!

FEATURES AND BENEFITS:

- Reduces setup, clean up, and labor costs.
- Heated tiles can be lifted **INTACT** preventing the harmful release of dust or hazardous materials.
- Removes up to six 12" x 12" tiles at a time!
- Massive 28" x 40" footprint!
- Rapid heat-up and cool down for efficient operation.
- All solid state electronics assure precision and reliability.
- Modular design, fully assembles and disassembles in less than 5 minutes for easy transport. These can even ship via UPS!
- Individual ceramic emitter strips on heat element are fully replaceable. No need to replace entire heat panel.
- All components are UL and CE listed and are covered by a one year warranty.



**THE PREMIER "INFRARED"
TILE STRIPPER!**

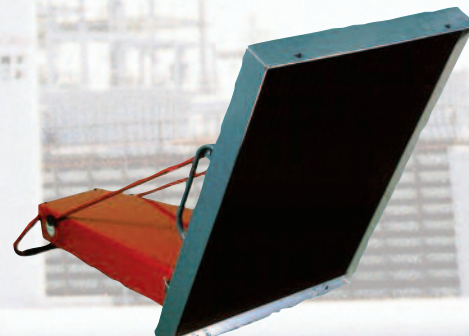

Model	Part No.	Weight	Height	Tile Removal	Power Requirements	Pad Size
Novastrip 1026	N1026	88 lbs	46"	9"x9"=12 12"x12"=6	220/240volt, 50amp, 1phase	28" x 40"

NOVASTRIP 378

INFRARED HEAT TILE MACHINE

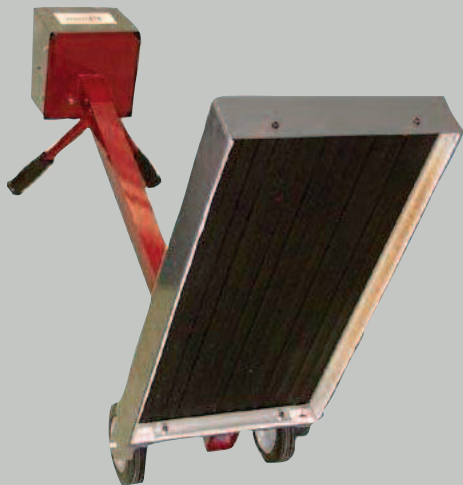

The 378 "Footprint"

NovaStrip 378 utilizes "Infrared Radiant Heat" at 110volts to safely heat tiles, thus breaking the adhesive bond. This allows you to lift "INTACT" tiles in a dustless environment. The NovaStrip 378 features individual ceramic emitter strips that are fully replaceable. No need to replace the entire heat panel.

To use, simply plug the unit into any 20 amp, 110volt grounded outlet, place the machine over tiles to be removed, allow it to complete its heating cycle, then easily remove the tiles.

Features and Benefits

- NEW midrange heater from Novatek
- 14"x 28" panel allows for 2 ft² removal
- Works off of a 110v - 20amp current
- NEW Processor features easier cycle settings
- Perfect compliment to the N1026

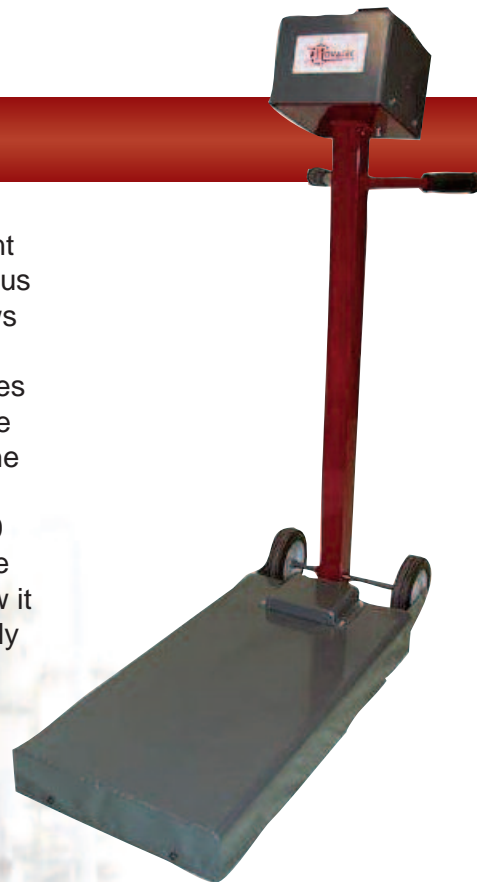

Model	Part No.	Weight	Height	Tile Removal	Power Requirements	Pad Size
NovaStrip 378	N378	45 lbs	46"	9"x9"=3 12"x12"=2	110volt, 15amp	14" x 28"

ECOSTRIP - INFRARED HEAT TILE MACHINE



EcoStrip 100 Control Panel

EcoStrip 100 gives a new meaning to a light weight, portable infrared heat tile machine. Weighing only 18lbs. and utilizing a 15 amp, 110volt grounded outlet makes this an all around winner. The EcoStrip heat panel also features individual ceramic emitter strips that are fully replaceable. No need to replace the entire heat panel.

Features and Benefits

- Perfect for steps, closets and compact areas
- Twenty minute motion switch automatically shuts down power if machine is left unattended
- Adjustable/Removable handle eliminates bending and operator fatigue



Model	Part No.	Weight	Height	Tile Removal	Power Requirements	Pad Size
EcoStrip 100	N100	18 lbs	35" to 44"	9"x9"=1 12"x12"=1	110volt, 15amp	14" x 14"

HEPA VACUUMS

BACKPACK & FLOOR

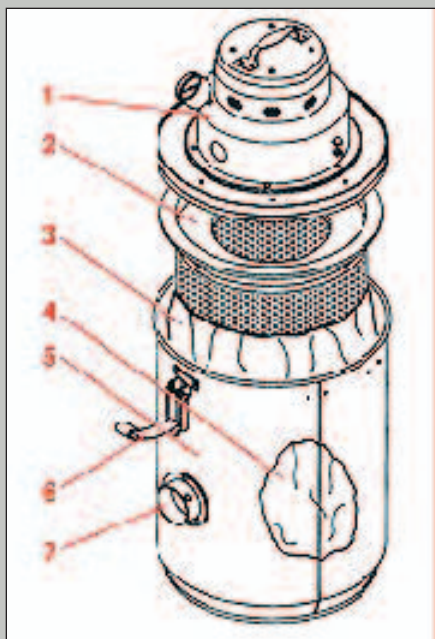

FEATURES & BENEFITS

1. POWERFUL VACUUM GENERATORS

- Exceeds performance specifications of equal capacity vacuums
- Super quiet, only 77 dB(A)
- Protected by a rugged, chrome plated, one piece steel dome cover

2. CUSTOM H.E.P.A. FILTER

- Meets military and "UL" specification 586 & 900 plus ANSI, AEC, OSHA, & EPA specifications
- Individually D.O.P. tested and certified for 99.97% efficiency against 0.3 micron size particles (per mil-std 282)

3. INTERMEDIATE FILTER

- Extends the life of the HEPA filter
- Two-ply, double seam construction
- Elastic top for proper fit around tank rim

4. DISPOSABLE FILTER BAG

- 2 Ply construction for initial filtration
- Self-adhesive seal patch to prevent material spillage (Backpack & 15Gal. only)

5. RECOVERY TANK

- Heavy gauge stainless steel/painted steel for long life and easy cleaning

6. DOWN LATCHES

- Sturdy 1" wide for secure locking

7. VACUUM HOSE & TANK CONNECTION

- Triple pin, all metal for positive lock & seal
- Crush-proof 1.5" hose with full 360° swivel



Air Backpack Vacuum
305.3100



Electric Backpack Vacuum
305.3150



Air Floor Vacuum
307.3100



Electric Floor Vacuum
307.3350

Backpack & Floor Vacuum Standard Accessories

- (2) Intermediate Pre-Filters
- (1) 1.5" Crush Proof Vac Hose 6ft Backpacks & 10ft Floor Vacs
- (5) Disposable 6mil. Poly Bags
- (5) Disposable Collection Bags
- (1) Hepa Filter (Not Shown)



Model	Part No.	CFM Output Flow	Static Lift Inches of H ₂ O	Air Consumption & SCFM	Recovery Capacity	Maximum Hose Length
Air Backpack Vacuum	305.3100	170	160"	50CFM@90PSI	3.3Gal.	75ft x 1.5"
Electric Backpack Vacuum	305.3150	110	110"	N/A	3.3Gal.	25ft x 1.5"
15Gal. Air Floor Vacuum	307.3100	170	160"	50CFM@90PSI	15Gal.	75ft x 1.5"
15Gal. Electric Floor Vacuum	307.3350	110	110"	N/A	15Gal.	25ft x 1.5"
55Gal. Air Wet/Dry Vacuum	308.3100	170	160"	50CFM@90PSI	35/55Gal.	75ft x 1.5"
55Gal. Electric Wet/Dry Vacuum	308.3150	110	110"	N/A	35/55Gal.	25ft x 1.5"
55Gal. Dual Venturi Wet/Dry Air Vacuum	308.3350	220	160"	110CFM@90PSI	35/55Gal.	3pcs-50ft x 1.5"
55Gal. Three Motor Wet/DryElectric Vacuum	308.3300	270	110"	N/A	35/55Gal.	3pcs-35ft x 1.5"

HEPA VACUUMS

BULK COLLECTION



FEATURES & BENEFITS

1. POWERFUL VACUUM GENERATORS

- Exceeds performance specifications of equal capacity vacuums
- Super quiet, only 77 dB(A)
- Protected by a rugged, chrome plated, one piece steel dome cover

2. CUSTOM H.E.P.A. FILTER

- Meets military and "UL" specification 586 & 900 plus ANSI, AEC, OSHA, & EPA specifications
- Individually D.O.P. tested and certified for 99.97% efficiency against 0.3 micron size particles (per mil-std 282)

3. INTERMEDIATE FILTER

- Extends the life of the HEPA filter
- Two-ply, double seam construction
- Elastic top for proper fit around tank rim

4. RECOVERY

- Heavy gauge steel 55Gal. Drum
(Note: Not Supplied with Vacuums)

5. DOWN LATCHES

- Sturdy 1" wide for secure locking

6. VACUUM HOSE & TANK CONNECTION

- Triple pin, all metal for positive lock & seal
- Crush-proof 1.5" hose with full 360° swivel



Air Dryer-
Standard on all
Air Vacuums



35/55 Gal. Air Vacuum
1 Port Single Venturi
308.3100



35/55 Gal. Electric Vacuum
1 Port Single Motor
308.3150



35/55 Gal. Dual Venturi
3 Port Vacuum
308.3350



CBS System / 8 Port Multi Tool
Vacuum



Model	Part No.	CFM Output Flow	Static Lift Inches of H ² O	Air Consumption & SCFM	Recovery Capacity	Maximum Hose Length
55Gal. Air Wet/Dry Vacuum	308.3100	170	160"	50CFM@90PSI	35/55Gal.	75ft x 1.5"
55Gal. Electric Wet/Dry Vacuum	308.3150	110	110"	N/A	35/55Gal.	25ft x 1.5"
55Gal. Dual Venturi Wet/Dry Air Vacuum	308.3350	220	160"	110CFM@90PSI	35/55Gal.	3pcs-50ft x 1.5"
55Gal. Three Motor Wet/DryElectric Vacuum	308.3300	270	110"	N/A	35/55Gal.	3pcs-35ft x 1.5"
CBS Kit "C" 4Port Collection System **	314.000C	360	12"	200CFM @ 100PSI	55Gal.	4pcs-50ft x 1.5"
CBS Kit "D" 8Port Collection System **	314.000D	720	12"	400CFM @ 100PSI	55Gal.	8pcs-50ft x 1.5"

** 4-Port & 8-Port Manifolds for CBS Systems Sold Separately
Note: 55 Gal. Steel drums not supplied with vacuums.

TRIDENT NEPTUNE

DECK SCALERS



6 Cutter Head
340.581



Heavy Duty Leaf Head
340.550



Thin Leaf Head
340.548

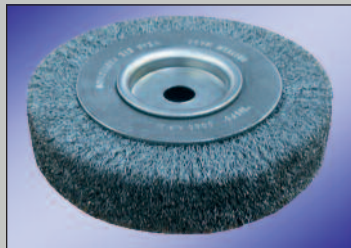

6" Power Brush
340.160



Twisted Knot Cup Brush
340.167

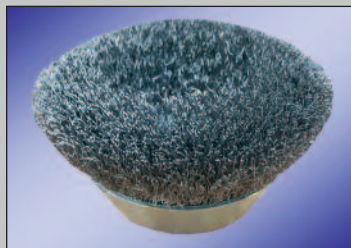

Crimped Wire Cup Brush
340.166



6" Twisted Wire Cup Brush
340.163

TRIDENT-NEPTUNE

The versatility of this deck scaler combined with reliability & quality has made this flexible shaft scaler the first choice for portable onboard de-scaling. The Trident Neptune will rapidly remove scale, rust, paint and other unwanted deposits or build-ups while leaving the surface ready for priming, painting or coating applications. This deck scaler is the ideal tool to reach into difficult areas on both horizontal and vertical surfaces. In addition to de-scaling decks, hatches, superstructures and wheelhouses, this machine allows work under piping and around areas previously inaccessible.

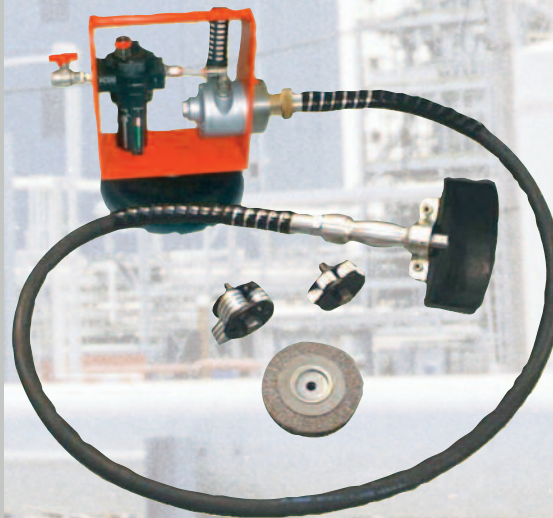
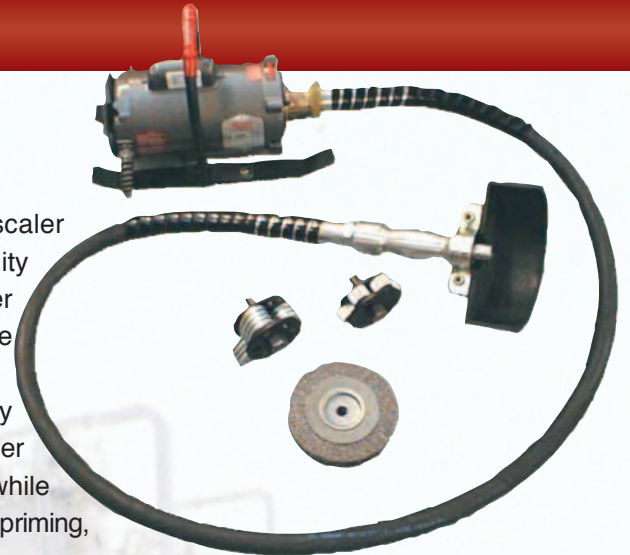

FEATURES AND BENEFITS:

- Choice of Power Source**
 - Electric or air models available
- Heavy Duty Construction**
 - 25% lighter than similar
 - Machines with ergonomic handle design
- Compact Design**
 - Access areas were other deck scalers cannot
- Motor Protection**
 - Automatic thermal protection on electric models
- Replaceable Accessories**
 - Multitude of different scaling heads, cutters, flails and brushes available

ALL MACHINES SUPPLIED WITH:

- Flexible shaft 10' long (3m) x 5/8" (16mm)
- Heavy Duty leaf scaling head
- 6 Cutter scaling head
- 6" Power brush
- Hand guard & Wrench set

Model	Part No.	Weight	Air / Power	Base	ISSA Code No.
110 Volt 50/60Hz Electric	340.TN/S/110	75lbs.	2hp	Skid	55.022.01
220 Volt 50/60Hz Electric	340.TN/S/220	75lbs	2hp	Skid	55.022.01
1.5HP Air	340.TN/S/490	70lbs.	66cfm@90psi 31.2lps@90psi	Swivel	55.022.01

HYDRAFLEX

HOLD CLEANING GUN



The Hydrflex has been specifically designed for Hold carriers and cargo vessels of all sizes.

The Hydrflex uses a combination of water and compressed air resulting in a powerful, tightly compressed jet of water able to reach up to 100 feet (30 meters) with adjustment to the control valve.

One man operation ensures hold cleaning time is reduced to an absolute minimum without the need of additional equipment such as scaffolding, pumps and scrapers.

FEATURES AND BENEFITS:

- Cleans Holds and Superstructures
- No Need for Trained Skilled Operator
- Easily Removes Cargo Residue, Flaking Paint and Rust
- Adjustable Control Valve Provides Suitable Jet Control for the Job at Hand
- High Quality Non-Corrosive Stainless Steel Material Ensures Almost Indefinite Life with Minimum Maintenance
- Easy & Fast Hook up with Instantaneous Couplings
- Choice of Water Hose Coupling Size 2" or 2 1/2"

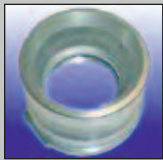

Hose Adapter
342.HY05



Hose Couplings
342.HY03 & 342.HY04



ISSA Code No. 55.085.01 (Gun) 55.085.02 (Tripod/Stand)

IMPA Code No. 59.07.42 Part No.(342.HY00/2 & 342 HY00/2.5)

Model	Part No.	Weight	Water Consumption (Recommended)	Water Pressure (Recommended)	Air Consumption (Recommended)	Air Pressure	Air Hose	Water Hose
Hydrflex Complete-Stand, Gun, 2" & 2 1/2" Coupling	342.HY00	Gun =13lbs (6kg) Stand = 20lbs (9kg) Total = 33lbs(15kg)	110 Gal./ Minute (485 Liter/Minute)	85 to 90 P.S.I. (6kg.cm ²)	71 cfm (2m ³ /minute)	100 to 120 P.S.I. (7 to 8 kg/cm ²)	3/4" (19mm)	2" (51mm) or 2 1/2"(64mm)
Hydrflex Complete-Stand, Gun and 2" Coupling	342.HY00/2	Gun =13lbs (6kg) Stand = 20lbs (9kg) Total = 33lbs(15kg)	110 Gal./ Minute (485 Liter/Minute)	85 to 90 P.S.I. (6kg.cm ²)	71 cfm (2m ³ /minute)	100 to 120 P.S.I. (7 to 8 kg/cm ²)	3/4" (19mm)	2" (51mm) or 2 1/2"(64mm)
Hydrflex Complete-Stand, Gun and 2 1/2" Coupling	342.HY00/2.5	Gun =13lbs (6kg) Stand = 20lbs (9kg) Total = 33lbs(15kg)	110 Gal./ Minute (485 Liter/Minute)	85 to 90 P.S.I. (6kg.cm ²)	71 cfm (2m ³ /minute)	100 to 120 P.S.I. (7 to 8 kg/cm ²)	3/4" (19mm)	2" (51mm) or 2 1/2"(64mm)

VACUUM BLASTING

CBS-CONTAINED BLAST SYSTEM

Specially designed component systems engineered for critical removal and recovery of lead-based paint, radioactive contaminants and other hazardous materials.



CBS WorkHead
314.0015



CBS WorkHead Kit
314.0020



Vacuum Pump Complete

The design of the CBS-Contained Blast System offers the maximum in efficiency and dependability. Vacuum blasting was introduced into the market not to replace open abrasive blasting, but to be utilized in situations where containment is critical. The CBS was engineered to be the most productive vacuum blast recovery unit to date. It is extremely low maintenance and highly versatile.



CBS System / 8 Port Multi Tool Vacuum

Our CBS units are efficient in coatings removal and will leave the surface to any desired specification, whether it be a brush-off blast or white metal finish. The CBS systems can be adapted to almost any existing blasting equipment on the market. If the situation calls for power tool cleaning, our CBS systems can easily be adapted for handling up to eight vacuum shrouded tools.

FEATURES AND BENEFITS:

Steel Workhead

- All steel body for maximum durability
- 360° swivelling nozzle allows the workhead to rotate around the nozzle, offering greater mobility and less fatigue to the operator
- Replaceable steel wear sleeves allow the use of virtually any blast nozzle
- Multiple brushes available for coatings removal on flat, inside corner and outside edge surfaces
- 3" blast pattern
- Can be fitted to all existing Blasting Equipment



Portable Vacuum Recovery

- Wide range of system options allows you to customize a unit to meet your needs
- Available with or without HEPA Filtration
- Dual vacuum pumps available for maximum vacuum flow
- Optional 4 or 8 port vacuum manifolds can be used to run vacuum shrouded power tools

Benefits of Vacuum Blasting

- Same results as open blasting without the mess
- Healthy, Safe, Dust-Free Environment
- Contains hazardous and non-hazardous materials without the need for an elaborate containment system
- Allows other work to be done in the same area while blasting is performed

Model	Part No.	Weight	Air Requirements	CFM / Static Lift Output Flow	Filtration
CBS WorkHead	314.0015	6lbs.	N/A	N/A	N/A
CBS WorkHead Kit	314.0020	10lbs.	N/A	N/A	N/A
CBS Kit "A" **	314.000A	220 lbs.	200CFM @ 100PSI	360cfm@ 13" Hg	Cartridge
CBS Kit "B" **	314.000B	280 lbs.	400CFM @ 100PSI	360cfm@ 13" Hg	Cartridge
CBS Kit "C" **	314.000C	420 lbs.	200CFM @ 100PSI	360cfm@ 13" Hg	Cartridge / Hepa
CBS Kit "D" **	314.000D	480 lbs.	400CFM @ 100PSI	720cfm@ 13" Hg	Cartridge / Hepa

** 4-Port & 8-Port Manifolds for CBS Systems Sold Separately
Note: 55 Gal. Steel drums not supplied with vacuums.

Toll Free: 866-563-7800

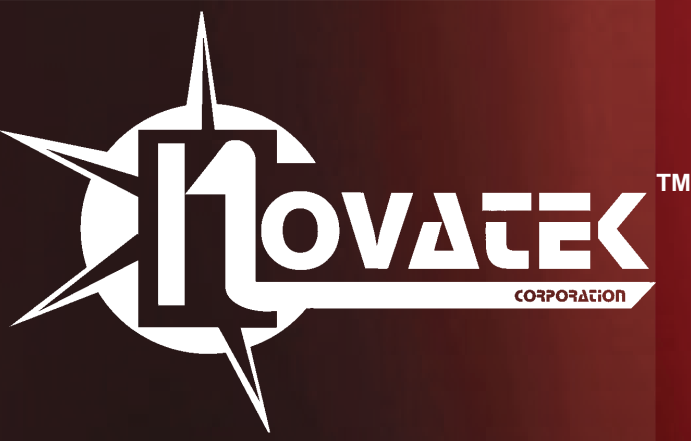

As a major source of surface preparation and air filtration equipment, Novatek is a valuable resource with over 60 years of combined experience. Novatek offers a wide variety of Pneumatic, Electric and Gas powered equipment ranging from portable hand tools to large walk behind machines. We specialize in manufacturing equipment for hazardous environments and can custom tailor systems for Lead paint removal, Radiological Denominations, PCB removals and Asbestos Abatement; that's just to name a few. Whether you are spot cleaning coatings or removing contaminated concrete, Novatek has the equipment to

"DO THE JOB AND DO IT WELL".



**B.P.M.=Blows Per Minute
lpm=Litres Per Minute
cfm=Cubic Foot/Minute
Aeq=Acceleration equivalent
LpA=Sound Pressure Level
LwA=Sound Power Level
psi=Pounds Per Square Inch**

NOVATEK CORPORATION

**155 Philips Road
Exton, PA. 19341**

Toll Free: 866-563-7800

Tel: 610-363-7800

Fax: 610-363-9620

Email: Sales@Novatekco.com

Cat.# -CB10



All of our equipment is thoroughly tested under specified conditions in accordance with applicable internationally recognized standards. When a tool is used on site the conditions may not be the same as those used in our tests.

Novatek Corporation operates a policy of continuous product development and refinement and therefore reserves the right to change technical specifications and product designs without giving prior notice.

For further information on any Novatek product do not hesitate to contact our customer service department at 866-563-7800.

Visit our website for more information, new product releases and latest offers

www.NovatekCo.com