

Parts

Hydro Force Pump AP120 PARTS ASSEMBLY

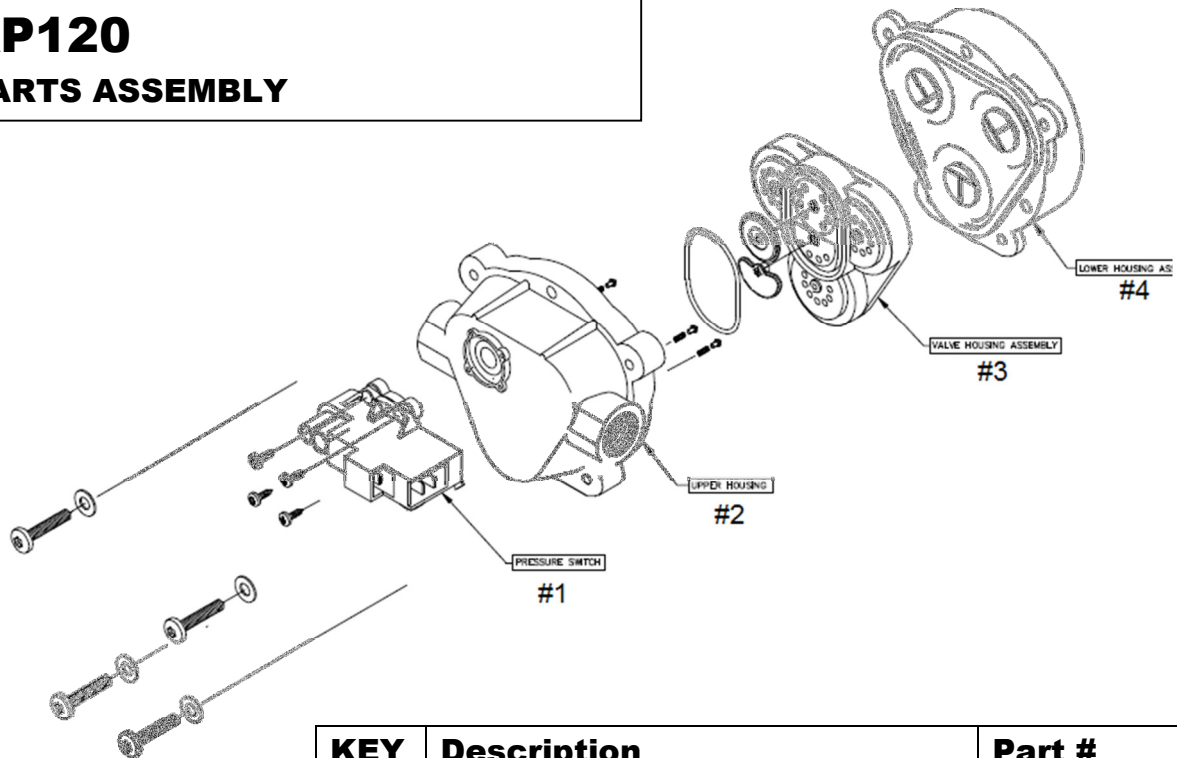

KEY	Description	Part #
1	Pressure Switch	PAQ01
2	Upper Housing Assembly	PAQ03
3	Valve Housing Assembly	PAQ04
4	Lower Housing Assembly	PAQ05
NS	Pump & Motor Complete	AP120

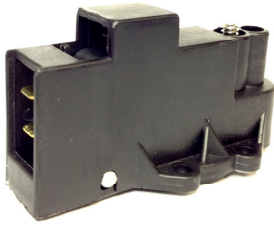

PAQ01



PAQ03



PAQ05



PAQ04

PERFORMANCE DATA			
NOZZLE SIZE	DISCHARGE PRESSURE (PSI)	FLOW (GPM)	CURRENT (AMPS)
NUMBER 2	95	0.25	0.95
NUMBER 4	83	0.65	0.92
NUMBER 6	70	0.80	0.84